

# LCA10S

LC A 10 S -5 -□

① ② ③ ④ ⑤ ⑥

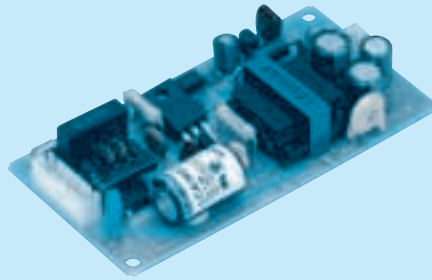

Recommended EMI/EMC Filter  
NAC-06-472



High voltage pulse noise type : NAP series  
Low leakage current type : NAM series  
\*The EMI/EMC Filter is recommended to connect with several devices.

- ① Series name
- ② 100/120V input
- ③ Output wattage
- ④ Single output
- ⑤ Output voltage
- ⑥ Optional \*3
- C :with Coating
- G :Low leakage current
- Y :with Potentiometer

MODEL	LCA10S-5	LCA10S-5-H	LCA10S-12	LCA10S-15	LCA10S-24
MAX OUTPUT WATTAGE[W]	10	10	10.8	10.5	12
DC OUTPUT	5V 2A	5V 2A	12V 0.9A	15V 0.7A	24V 0.5A

## SPECIFICATIONS

	MODEL	LCA10S-5	LCA10S-5-H	LCA10S-12	LCA10S-15	LCA10S-24	
INPUT	VOLTAGE[V]	AC85 - 132 1 φ or DC110 - 170					
	CURRENT[A]	ACIN 100V	0.3typ (Io=100%)				
	FREQUENCY[Hz]	47 - 440 or DC					
	EFFICIENCY[%]		71typ	71typ	75typ	75typ	78typ
	INRUSH CURRENT[A]	ACIN 100V	25typ (Io=100%)				
	LEAKAGE CURRENT[ma]	0.5max (60Hz, According to UL, CSA and DEN-AN)					
OUTPUT	VOLTAGE[V]	5	5	12	15	24	
	CURRENT[A]	2	2 (Peak 3)	0.9	0.7	0.5	
	LINE REGULATION[mV]	20max	20max	48max	60max	96max	
	LOAD REGULATION[mV]	40max	40max	100max	120max	150max	
	RIPPLE[mVp-p]	0 to +50°C *1	80max	80max	120max	120max	120max
		-10 - 0°C *1	140max	140max	160max	160max	160max
	RIPPLE NOISE[mVp-p]	0 to +50°C *1	120max	120max	150max	150max	150max
		-10 - 0°C *1	160max	160max	180max	180max	180max
	TEMPERATURE REGULATION[mV]	50max	50max	120max	150max	240max	
	DRIFT[mV]	*2	20max	20max	48max	60max	96max
START-UP TIME[ms]	100max (ACIN 85V, Io=100%)						
HOLD-UP TIME[ms]	10typ (ACIN 85V, Io=100%) 20typ (ACIN 100V, Io=100%)						
OUTPUT VOLTAGE ADJUSTMENT RANGE[V]	Fixed ("Y" which can be adjusted the output is available as optional: 5V -5 to +10% : 12, 15, 24V ±10%)						
OUTPUT VOLTAGE SETTING[V]	4.9 - 5.3	4.9 - 5.3	11.5 - 12.5	14.4 - 15.6	23.0 - 25.0		
PROTECTION CIRCUIT AND OTHERS	OVERCURRENT PROTECTION	Works over 105% of rating (works over 105% of peak current at option -H) and recovers automatically					
	OVERVOLTAGE PROTECTION	Works over 115% of rating, by zener diode clamping					
	OPERATING INDICATION	Not provided					
	REMOTE SENSING	Not provided					
	REMOTE ON/OFF	Not provided					
ISOLATION	INPUT-OUTPUT	AC2,000V 1minute, Cutoff current = 10mA, DC500V 50MΩ min (At Room Temperature)					
	INPUT-FG	AC2,000V 1minute, Cutoff current = 10mA, DC500V 50MΩ min (At Room Temperature)					
	OUTPUT-FG	AC500V 1minute, Cutoff current = 100mA, DC500V 50MΩ min (At Room Temperature)					
ENVIRONMENT	OPERATING TEMP., HUMID. AND ALTITUDE	-10 to +60°C, 20 - 90%RH (Non condensing) (Refer to DERATING CURVE), 3,000m (10,000feet) max					
	STORAGE TEMP., HUMID. AND ALTITUDE	-20 to +75°C, 20 - 90%RH (Non condensing), 9,000m (30,000feet) max					
	VIBRATION	10 - 55Hz, 19.6m/s <sup>2</sup> (2G), 3minutes period, 60minutes each along X, Y and Z axis					
	IMPACT	196.1m/s <sup>2</sup> (20G), 11ms, once each X, Y and Z axis					
SAFETY AND NOISE REGULATIONS	AGENCY APPROVALS	UL60950-1, CSA C22.2 No.60950-1 Complies with DEN-AN					
	CONDUCTED NOISE	Complies with FCC-B, VCCI-B					
OTHERS	CASE SIZE/WEIGHT	49 × 17 × 94mm (W × H × D) / 65g max					
	COOLING METHOD	Convection					

\*1 Measured by 20MHz oscilloscope or Ripple-Noise meter (equivalent to KEISOKU-GIKEN : RM101).  
 \*2 Drift is the change in DC output for an eight hour period after a half-hour warm-up at 25°C with the input voltage held constant at the rated input/output.  
 \*3 Please contact us about safety approvals for the model with option.  
 \* Avoid prolonged use under over-load.

External view

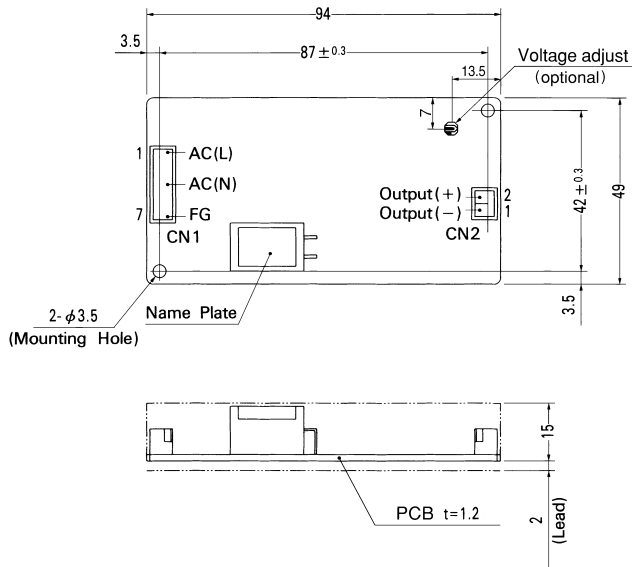

I/O Connector	Mating Connector	Terminal
CN1	B3(7.5)B-XH-A	XHP-7
		Chain: SXH-001T-P0.6 Loose: BXH-001T-P0.6
CN2	B2B-XH-A	XHP-2
		Chain: SXH-001T-P0.6 Loose: BXH-001T-P0.6

(Mfr.: J.S.T.)

<PIN CONNECTION>

Pin No.	Input
1	AC(L)
2	
3	
4	AC(N)
5	
6	
7	FG

  

Pin No.	Output
1	-V
2	+V

- ※ Weight : 65g or less
- ※ Tolerance : ± 1
- ※ Dimensions in mm.
- ※ PCB Material : Glass composite (CEM3)

Performance data

■ STATIC CHARACTERISTICS (LCA10S-5)

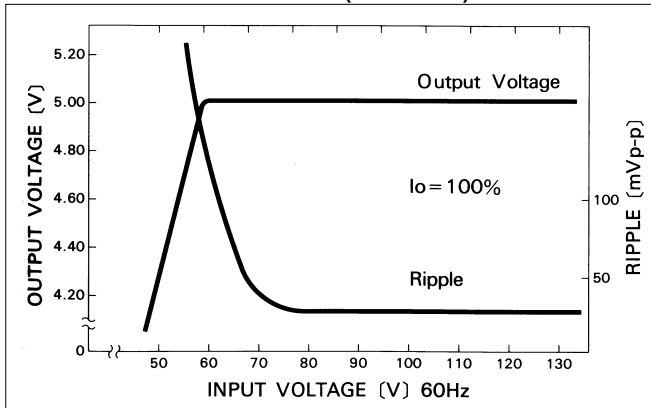

■ RISE TIME & FALL TIME (LCA10S-5)

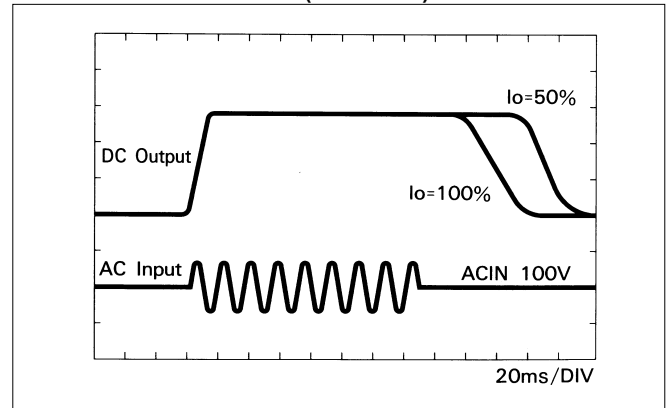

■ OVERCURRENT CHARACTERISTICS (LCA10S-5)

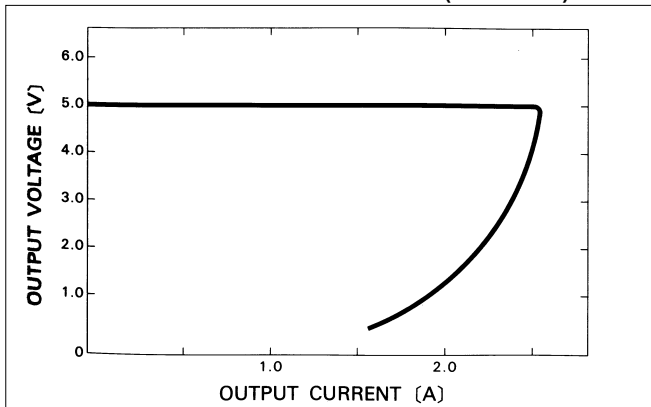

■ DERATING CURVE

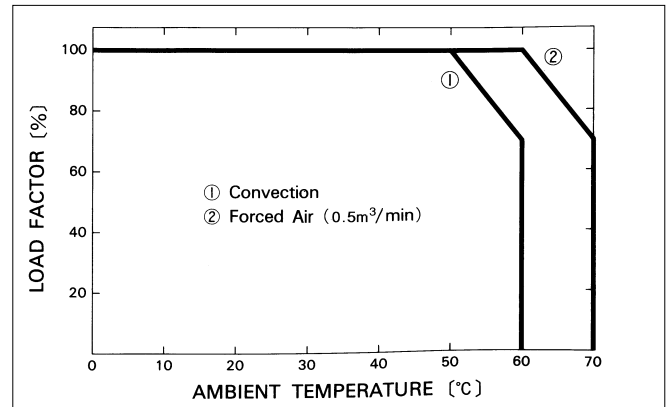

# LCA15S

LC A 15 S -5 -□

① ② ③ ④ ⑤ ⑥

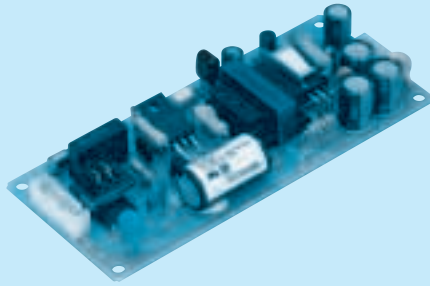

Recommended EMI/EMC Filter  
NAC-06-472



High voltage pulse noise type : NAP series  
Low leakage current type : NAM series  
\*The EMI/EMC Filter is recommended to connect with several devices.

- ① Series name
- ② 100/120V input
- ③ Output wattage
- ④ Single output
- ⑤ Output voltage
- ⑥ Optional \*3
- C :with Coating
- G :Low leakage current
- Y :with Potentiometer

MODEL	LCA15S-5	LCA15S-12	LCA15S-15	LCA15S-24
MAX OUTPUT WATTAGE[W]	15	15.6	15	16.8
DC OUTPUT	5V 3A	12V 1.3A	15V 1A	24V 0.7A

## SPECIFICATIONS

	MODEL	LCA15S-5	LCA15S-12	LCA15S-15	LCA15S-24	
INPUT	VOLTAGE[V]	AC85 - 132 1 φ or DC110 - 170				
	CURRENT[A]	ACIN 100V	0.4typ (Io=100%)			
	FREQUENCY[Hz]	47 - 440 or DC				
	EFFICIENCY[%]	72typ		75typ		
	INRUSH CURRENT[A]	ACIN 100V	20typ (Io=100%) (At cold start)			
	LEAKAGE CURRENT[ma]	0.5max (60Hz, According to UL, CSA and DEN-AN)				
OUTPUT	VOLTAGE[V]	5	12	15	24	
	CURRENT[A]	3	1.3	1	0.7	
	LINE REGULATION[mV]	20max	48max	60max	96max	
	LOAD REGULATION[mV]	40max	100max	120max	150max	
	RIPPLE[mVp-p]	0 to +50°C *1	80max	120max	120max	120max
		-10 - 0°C *1	140max	160max	160max	160max
	RIPPLE NOISE[mVp-p]	0 to +50°C *1	120max	150max	150max	150max
		-10 - 0°C *1	160max	180max	180max	180max
	TEMPERATURE REGULATION[mV]	50max	120max	150max	240max	
	DRIFT[mV]	*2	20max	48max	60max	96max
	START-UP TIME[ms]	100max (ACIN 85V, Io=100%)				
HOLD-UP TIME[ms]	10typ (ACIN 85V, Io=100%) 20typ (ACIN 100V, Io=100%)					
OUTPUT VOLTAGE ADJUSTMENT RANGE[V]	Fixed ("Y"which can be adjusted the output is available as optional:5V -5 to +10% : 12, 15, 24V ±10%)					
OUTPUT VOLTAGE SETTING[V]	4.9 - 5.3	11.5 - 12.5	14.4 - 15.6	23.0 - 25.0		
PROTECTION CIRCUIT AND OTHERS	OVERCURRENT PROTECTION	Works over 105% of rating and recovers automatically				
	OVERVOLTAGE PROTECTION	Works over 115% of rating, by zener diode clamping				
	OPERATING INDICATION	Not provided				
	REMOTE SENSING	Not provided				
	REMOTE ON/OFF	Not provided				
ISOLATION	INPUT-OUTPUT	AC2,000V 1minute, Cutoff current = 10mA, DC500V 50MΩ min (At Room Temperature)				
	INPUT-FG	AC2,000V 1minute, Cutoff current = 10mA, DC500V 50MΩ min (At Room Temperature)				
	OUTPUT-FG	AC500V 1minute, Cutoff current = 100mA, DC500V 50MΩ min (At Room Temperature)				
ENVIRONMENT	OPERATING TEMP.,HUMID.AND ALTITUDE	-10 to +60°C, 20 - 90%RH (Non condensing) (Refer to DERATING CURVE), 3,000m (10,000feet) max				
	STORAGE TEMP.,HUMID.AND ALTITUDE	-20 to +75°C, 20 - 90%RH (Non condensing), 9,000m (30,000feet) max				
	VIBRATION	10 - 55Hz, 19.6m/s <sup>2</sup> (2G), 3minutes period, 60minutes each along X, Y and Z axis				
	IMPACT	196.1m/s <sup>2</sup> (20G), 11ms, once each X, Y and Z axis				
SAFETY AND NOISE REGULATIONS	AGENCY APPROVALS	UL60950-1, CSA C22.2 No.60950-1 Complies with DEN-AN				
	CONDUCTED NOISE	Complies with FCC-B, VCCI-B				
OTHERS	CASE SIZE/WEIGHT	50 X 17 X 115mm (W X H X D) / 80g max				
	COOLING METHOD	Convection				

\*1 Measured by 20MHz oscilloscope or Ripple-Noise meter(equivalent to KEISOKU-GIKEN : RM101).  
 \*2 Drift is the change in DC output for a eight hour period after a half-hour warm-up at 25°C with the input voltage held constant at the rated input/output.  
 \*3 Please contact us about safety approvals for the model with option.  
 \* Avoid prolonged use under over-load.

External view

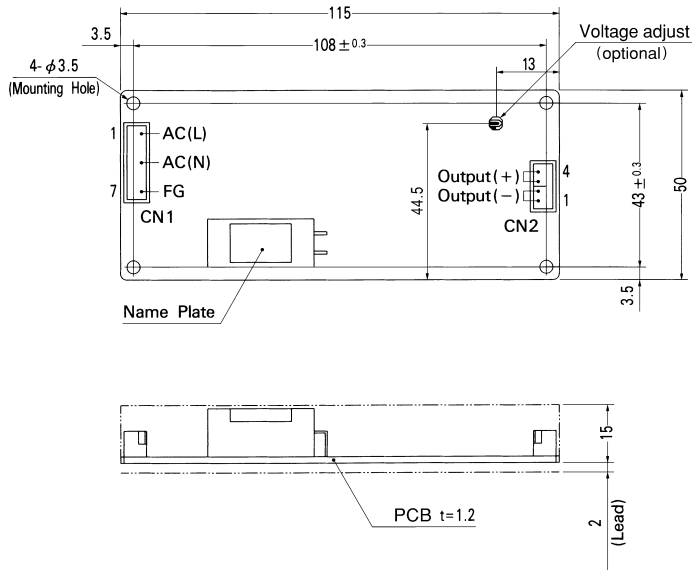

I/O Connector	Mating Connector	Terminal
CN1	B3(7.5)B-XH-A	XHP-7
		Chain: SXH-001T-P0.6
		Loose: BXH-001T-P0.6
CN2	B4B-XH-A	XHP-4
		Chain: SXH-001T-P0.6
		Loose: BXH-001T-P0.6

(Mfr.: J.S.T.)

<PIN CONNECTION>

Pin No.	Input
1	AC(L)
2	
3	
4	AC(N)
5	
6	
7	FG

Pin No.	Output
1, 2	-V
3, 4	+V

\*Maximum 2A per pin of CN2 can be applied.

- \*Weight: 80g or less
- \*Tolerance: ±1
- \*Dimensions in mm.
- \*PCB Material: Glass composite (CEM3)

Performance data

■ STATIC CHARACTERISTICS (LCA15S-5)

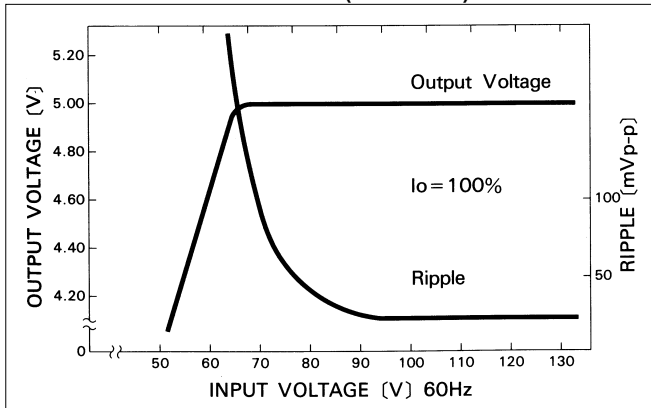

■ RISE TIME & FALL TIME (LCA15S-5)

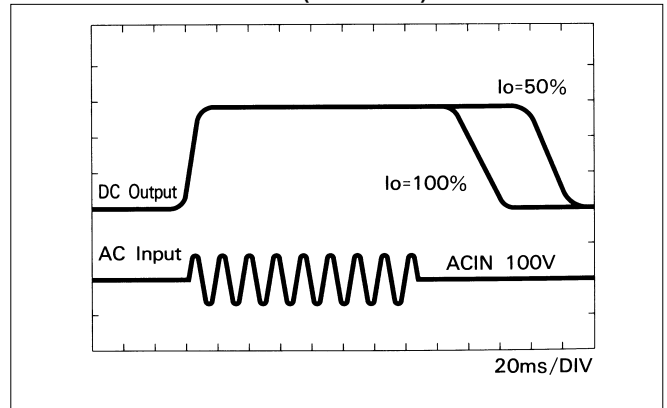

■ OVERCURRENT CHARACTERISTICS (LCA15S-5)

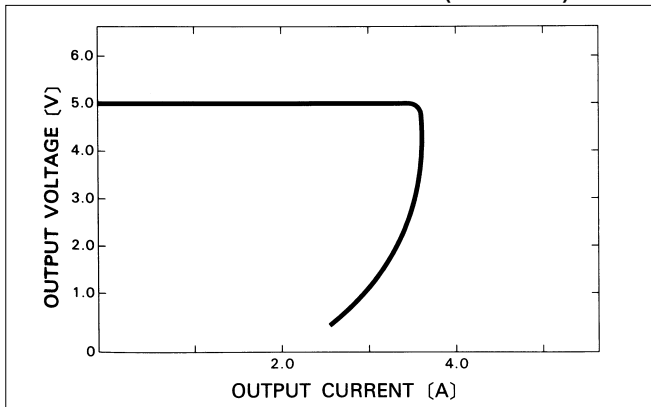

■ DERATING CURVE

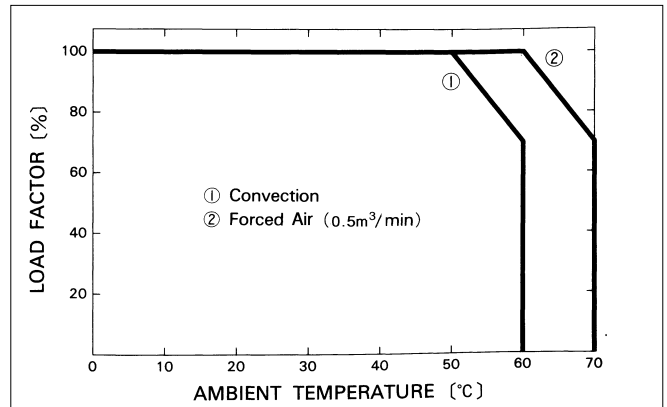

# LCA30S

LC A 30 S -5 -□

① ② ③ ④ ⑤ ⑥

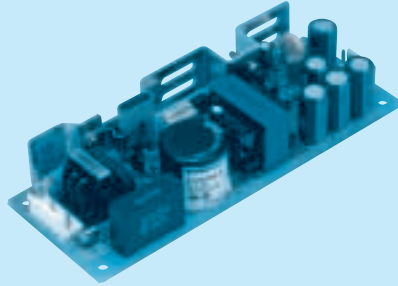

Recommended EMI/EMC Filter  
NAC-06-472



High voltage pulse noise type : NAP series  
Low leakage current type : NAM series  
\*The EMI/EMC Filter is recommended to connect with several devices.

- ① Series name
- ② 100/120V input
- ③ Output wattage
- ④ Single output
- ⑤ Output voltage
- ⑥ Optional \*3
- C :with Coating
- G :Low leakage current
- Y :with Potentiometer

MODEL	LCA30S-3	LCA30S-5	LCA30S-12	LCA30S-15	LCA30S-24	LCA30S-36	LCA30S-48
MAX OUTPUT WATTAGE[W]	18	30	30	30	31.2	32.4	33.6
DC OUTPUT	3V 6A	5V 6A	12V 2.5A	15V 2A	24V 1.3A	36V 0.9A	48V 0.7A

## SPECIFICATIONS

	MODEL	LCA30S-3	LCA30S-5	LCA30S-12	LCA30S-15	LCA30S-24	LCA30S-36	LCA30S-48	
INPUT	VOLTAGE[V]	AC85 - 132 1 φ or DC110 - 170							
	CURRENT[A]	ACIN 100V	0.7typ (Io=100%)						
	FREQUENCY[Hz]	47 - 440 or DC							
	EFFICIENCY[%]		69typ	75typ	80typ	81typ	82typ	80typ	80typ
	INRUSH CURRENT[A]	ACIN 100V	25typ (Io=100%) (At cold start)						
	LEAKAGE CURRENT[ma]	0.5max (60Hz, According to UL, CSA and DEN-AN)							
OUTPUT	VOLTAGE[V]	3	5	12	15	24	36	48	
	CURRENT[A]	6	6	2.5	2	1.3	0.9	0.7	
	LINE REGULATION[mV]	20max	20max	48max	60max	96max	144max	192max	
	LOAD REGULATION[mV]	40max	40max	100max	120max	150max	240max	300max	
	RIPPLE[mVp-p]	0 to +50°C *1	80max	80max	120max	120max	120max	150max	150max
		-10 - 0°C *1	140max	140max	160max	160max	160max	200max	200max
	RIPPLE NOISE[mVp-p]	0 to +50°C *1	120max	120max	150max	150max	150max	250max	350max
		-10 - 0°C *1	160max	160max	180max	180max	180max	300max	400max
	TEMPERATURE REGULATION[mV]	50max	50max	120max	150max	240max	360max	480max	
	DRIFT[mV]	*2	20max	20max	48max	60max	96max	144max	192max
START-UP TIME[ms]	100max (ACIN 85V, Io=100%)								
HOLD-UP TIME[ms]	10typ (ACIN 85V, Io=100%) 20typ (ACIN 100V, Io=100%)								
OUTPUT VOLTAGE ADJUSTMENT RANGE[V]	2.85 - 3.6	Fixed ("Y"which can be adjusted the output is available as optional:5V -5 to +10% : 12, 15, 24, 36, 48V ±10%)							
OUTPUT VOLTAGE SETTING[V]	—	4.9 - 5.3	11.5 - 12.5	14.4 - 15.6	23.0 - 25.0	34.5 - 37.5	46.0 - 50.0		
PROTECTION CIRCUIT AND OTHERS	OVERCURRENT PROTECTION	Works over 105% of rating and recovers automatically							
	OVERVOLTAGE PROTECTION	4.00V min	Works over 115% of rating, by zener diode clamping						
	OPERATING INDICATION	Not provided							
	REMOTE SENSING	Not provided							
	REMOTE ON/OFF	Not provided							
ISOLATION	INPUT-OUTPUT	AC2,000V 1minute, Cutoff current = 10mA, DC500V 50MΩ min (At Room Temperature)							
	INPUT-FG	AC2,000V 1minute, Cutoff current = 10mA, DC500V 50MΩ min (At Room Temperature)							
	OUTPUT-FG	AC500V 1minute, Cutoff current = 100mA, DC500V 50MΩ min (At Room Temperature)							
ENVIRONMENT	OPERATING TEMP.,HUMID.AND ALTITUDE	-10 to +60°C, 20 - 90%RH (Non condensing) (Refer to DERATING CURVE), 3,000m (10,000feet) max							
	STORAGE TEMP.,HUMID.AND ALTITUDE	-20 to +75°C, 20 - 90%RH (Non condensing), 9,000m (30,000feet) max							
	VIBRATION	10 - 55Hz, 19.6m/s <sup>2</sup> (2G), 3minutes period, 60minutes each along X, Y and Z axis							
	IMPACT	196.1m/s <sup>2</sup> (20G), 11ms, once each X, Y and Z axis							
SAFETY AND NOISE REGULATIONS	AGENCY APPROVALS	UL60950-1, CSA C22.2 No.60950-1 Complies with DEN-AN							
	CONDUCTED NOISE	Complies with FCC-B, VCCI-B							
OTHERS	CASE SIZE/WEIGHT	50 × 25 × 132.5mm (W × H × D) / 150g max							
	COOLING METHOD	Convection							

\*1 Measured by 20MHz oscilloscope or Ripple-Noise meter(equivalent to KEISOKU-GIKEN : RM101).  
 \*2 Drift is the change in DC output for a eight hour period after a half-hour warm-up at 25°C with the input voltage held constant at the rated input/output.  
 \*3 Please contact us about safety approvals for the model with option.  
 \* Avoid prolonged use under over-load.

External view

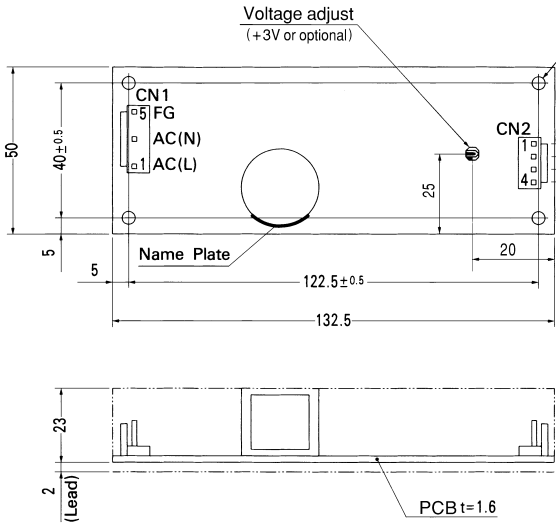

I/O Connector	Mating Connector	Terminal
CN1	B3P5-VH	VHR-5N
		Chain: SVH-21T-P1.1
		Loose: BVH-21T-P1.1
CN2	B4P-VH	XHR-4N
		Chain: SVH-21T-P1.1
		Loose: BVH-21T-P1.1

(Mfr.: J.S.T.)

<PIN CONNECTION>

Pin No.	Input	Pin No.	Output
1	AC(L)	1	-V
2	AC(N)	2	-V
3	AC(N)	3	+V
4	AC(N)	4	+V
5	FG		

- ※ Maximum 5A per pin of CN2 can be applied.
- ※ Weight : 150g or less
- ※ Tolerance : ±1
- ※ Dimensions in mm.
- ※ PCB Material : Glass composite (CEM3)

Performance data

■ STATIC CHARACTERISTICS (LCA30S-5)

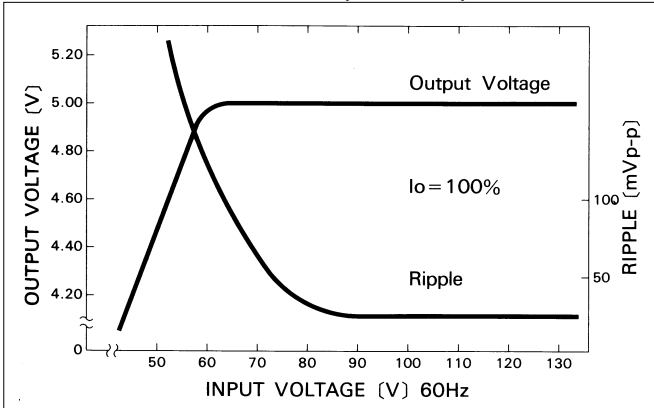

■ RISE TIME & FALL TIME (LCA30S-5)

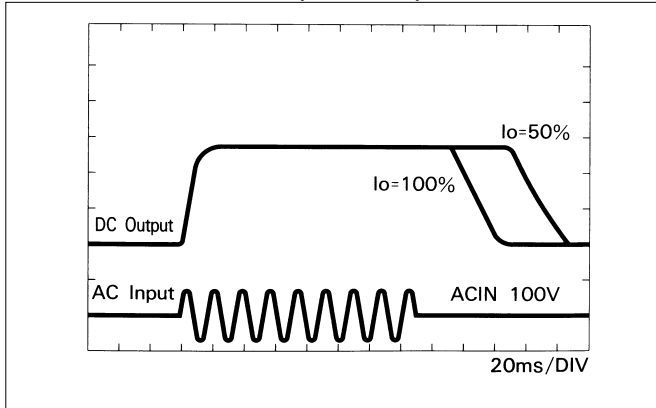

■ OVERCURRENT CHARACTERISTICS (LCA30S-5)

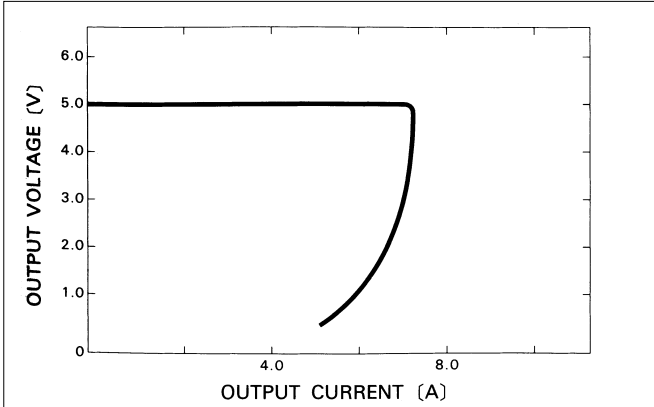

■ DERATING CURVE

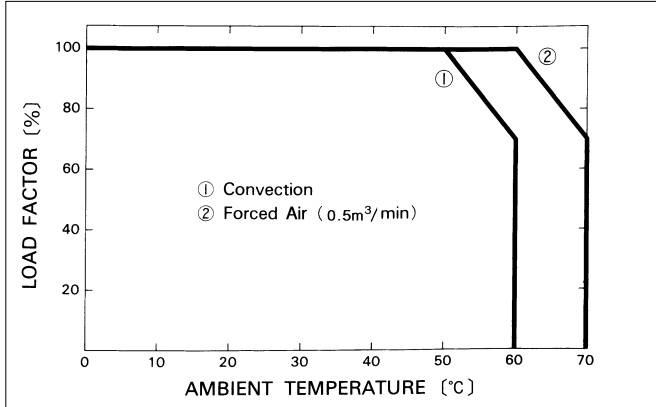

# LCA50S

LC A 50 S -5 -□

① ② ③ ④ ⑤ ⑥

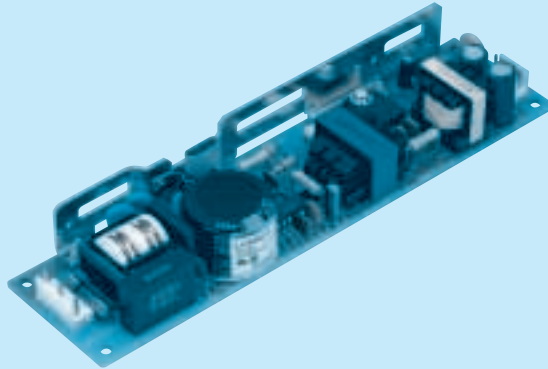

Recommended EMI/EMC Filter  
NAC-06-472



High voltage pulse noise type : NAP series  
Low leakage current type : NAM series  
\*The EMI/EMC Filter is recommended to connect with several devices.

- ① Series name
- ② 100/120V input
- ③ Output wattage
- ④ Single output
- ⑤ Output voltage
- ⑥ Optional \*4  
C : with Coating  
G : Low leakage current  
Y : with Potentiometer

MODEL	LCA50S-3	LCA50S-5	LCA50S-12	LCA50S-15	LCA50S-24	LCA50S-24-H	LCA50S-36	LCA50S-48
MAX OUTPUT WATTAGE[W]	30	50	51.6	52.5	60	60	61.2	62.4
DC OUTPUT	3V 10A	5V 10A	12V 4.3A	15V 3.5A	24V 2.5A	24V 2.5A	36V 1.7A	48V 1.3A

## SPECIFICATIONS

	MODEL	LCA50S-3	LCA50S-5	LCA50S-12	LCA50S-15	LCA50S-24	LCA50S-24-H	LCA50S-36	LCA50S-48	
LCA INPUT	VOLTAGE[V]	AC85 - 132 1 φ or DC110 - 170								
	CURRENT[A]	ACIN 100V 1.3typ (Io=100%)								
	FREQUENCY[Hz]	47 - 440 or DC								
	EFFICIENCY[%]	71typ	78typ	80typ	81typ	82typ	82typ	82typ	82typ	
	INRUSH CURRENT[A]	ACIN 100V 30typ (Io=100%) (At cold start)								
	LEAKAGE CURRENT[ma]	0.5max (60Hz, According to UL, CSA and DEN-AN)								
OUTPUT	VOLTAGE[V]	3	5	12	15	24	24	36	48	
	CURRENT[A]	*3 10	10	4.3	3.5	2.5	2.5 (Peak 3)	1.7	1.3	
	LINE REGULATION[mV]	20max	20max	48max	60max	96max	96max	144max	192max	
	LOAD REGULATION[mV]	40max	40max	100max	120max	150max	150max	240max	300max	
	RIPPLE[mVp-p]	0 to +50°C *1	80max	80max	120max	120max	120max	120max	150max	150max
		-10 - 0°C *1	140max	140max	160max	160max	160max	160max	200max	200max
	RIPPLE NOISE[mVp-p]	0 to +50°C *1	120max	120max	150max	150max	150max	150max	250max	350max
		-10 - 0°C *1	160max	160max	180max	180max	180max	180max	300max	400max
	TEMPERATURE REGULATION[mV]	0 to +50°C	50max	50max	120max	150max	240max	240max	360max	480max
		-10 to +50°C	60max	60max	150max	180max	290max	290max	450max	600max
	DRIFT[mV]	*2 20max	20max	48max	60max	96max	96max	144max	192max	
	START-UP TIME[ms]	200max (ACIN 85V, Io=100%)								
	HOLD-UP TIME[ms]	10typ (ACIN 85V, Io=100%) 20typ (ACIN 100V, Io=100%)								
OUTPUT VOLTAGE ADJUSTMENT RANGE[V]	2.85 - 3.6 Fixed ("Y" which can be adjusted the output is available as optional: 5, 12, 15, 24, 36, 48V ±10%)									
OUTPUT VOLTAGE SETTING[V]	—	4.9 - 5.3	11.5 - 12.5	14.4 - 15.6	23.0 - 25.0	23.0 - 25.0	34.5 - 37.5	46.0 - 50.0		
PROTECTION CIRCUIT AND OTHERS	OVERCURRENT PROTECTION	Works over 105% of rating (works over 105% of peak current at option -H) and recovers automatically								
	OVERVOLTAGE PROTECTION	4.00 - 5.25V Works at 115 - 140% of rating								
	OPERATING INDICATION	Not provided								
	REMOTE SENSING	Not provided								
ISOLATION	REMOTE ON/OFF	Not provided								
	INPUT-OUTPUT	AC2,000V 1minute, Cutoff current = 10mA, DC500V 50MΩ min (At Room Temperature)								
ENVIRONMENT	INPUT-FG	AC2,000V 1minute, Cutoff current = 10mA, DC500V 50MΩ min (At Room Temperature)								
	OUTPUT-FG	AC500V 1minute, Cutoff current = 100mA, DC500V 50MΩ min (At Room Temperature)								
SAFETY AND NOISE REGULATIONS	OPERATING TEMP., HUMID. AND ALTITUDE	-10 to +60°C, 20 - 90%RH (Non condensing) (Refer to DERATING CURVE), 3,000m (10,000feet) max								
	STORAGE TEMP., HUMID. AND ALTITUDE	-20 to +75°C, 20 - 90%RH (Non condensing), 9,000m (30,000feet) max								
	VIBRATION	10 - 55Hz, 19.6m/s <sup>2</sup> (2G), 3minutes period, 60minutes each along X, Y and Z axis								
OTHERS	IMPACT	196.1m/s <sup>2</sup> (20G), 11ms, once each X, Y and Z axis								
	AGENCY APPROVALS	UL60950-1, CSA C22.2 No.60950-1 Complies with DEN-AN								
OTHERS	CONDUCTED NOISE	Complies with FCC-B, VCCI-B								
	CASE SIZE/WEIGHT	50 X 25 X 195mm (W X H X D) / 200g max								
	COOLING METHOD	Convection								

\*1 Measured by 20MHz oscilloscope or Ripple-Noise meter (equivalent to KEISOKU-GIKEN : RM101).  
 \*2 Drift is the change in DC output for an eight hour period after a half-hour warm-up at 25°C with the input voltage held constant at the rated input/output.  
 \*3 Peak load for 10 sec. or less is acceptable (The average current has to be less than the rated current).  
 \*4 Please contact us about safety approvals for the model with option.



External view

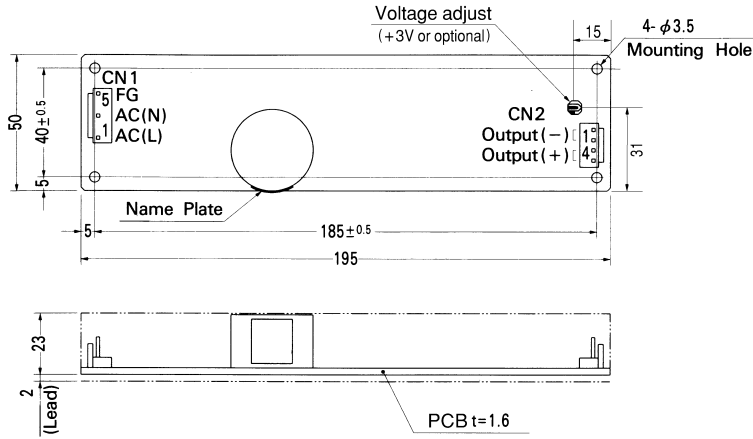

I/O Connector	Mating Connector	Terminal
CN1	B3P5-VH	VHR-5N Chain: SVH-21T-P1.1 Loose: BVH-21T-P1.1
CN2	B4P-VH	VHR-4N Chain: SVH-21T-P1.1 Loose: BVH-21T-P1.1

(Mfr.: J.S.T.)

<PIN CONNECTION>

Pin No.	Input
1	AC(L)
2	
3	AC(N)
4	
5	FG

Pin No.	Output
1 · 2	-V
3 · 4	+V

※ Maximum 5A per pin of CN2 can be applied.

- ※ Weight: 200g or less
- ※ Tolerance: ±1
- ※ Dimensions in mm.
- ※ PCB Material: Glass composite (CEM3)

Performance data

■ STATIC CHARACTERISTICS (LCA50S-5)

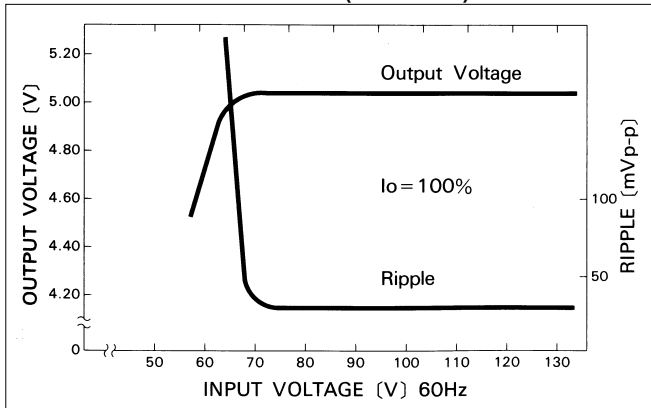

■ RISE TIME & FALL TIME (LCA50S-5)

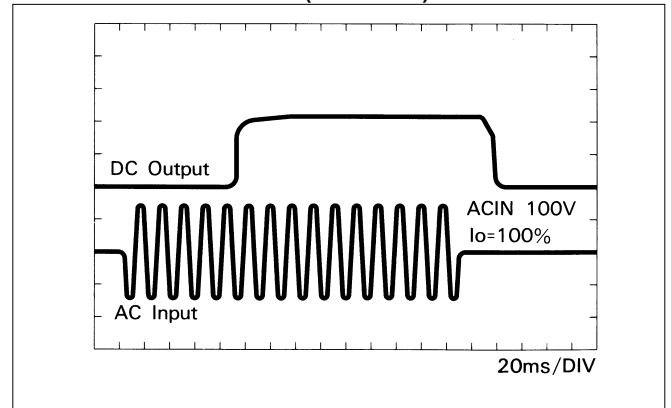

■ OVERCURRENT CHARACTERISTICS (LCA50S-5)

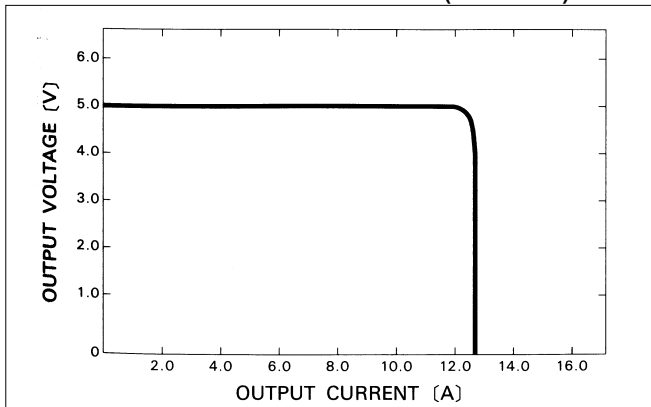

■ DERATING CURVE

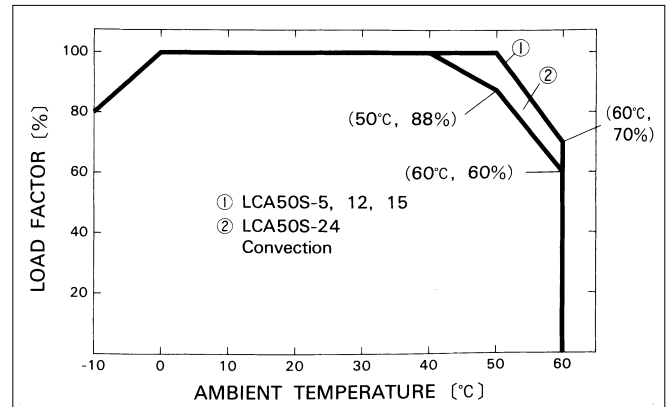



# LCA75S

LC A 75 S -5 -□

① ② ③ ④ ⑤ ⑥

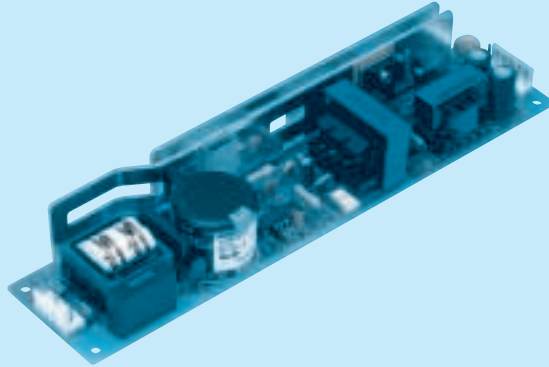

Recommended EMI/EMC Filter  
NAC-06-472



High voltage pulse noise type : NAP series  
Low leakage current type : NAM series  
\*The EMI/EMC Filter is recommended to connect with several devices.

- ① Series name
- ② 100/120V input
- ③ Output wattage
- ④ Single output
- ⑤ Output voltage
- ⑥ Optional \*4
- C : with Coating
- G : Low leakage current
- Y : with Potentiometer

MODEL	LCA75S-3	LCA75S-5	LCA75S-12	LCA75S-15	LCA75S-24	LCA75S-24-H	LCA75S-36	LCA75S-48
MAX OUTPUT WATTAGE[W]	45	75	75.6	75	76.8	76.8	75.6	76.8
DC OUTPUT	3V 15A	5V 15A	12V 6.3A	15V 5A	24V 3.2A	24V 3.2A	36V 2.1A	48V 1.6A

## SPECIFICATIONS

	MODEL	LCA75S-3	LCA75S-5	LCA75S-12	LCA75S-15	LCA75S-24	LCA75S-24-H	LCA75S-36	LCA75S-48	
LCA INPUT	VOLTAGE[V]	AC85 - 132 1 φ or DC110 - 170								
	CURRENT[A]	ACIN 100V 1.9typ (Io=100%)								
	FREQUENCY[Hz]	47 - 440 or DC								
	EFFICIENCY[%]	72typ	79typ	81typ	83typ	84typ	84typ	84typ	84typ	
	INRUSH CURRENT[A]	ACIN 100V 30typ (Io=100%) (At cold start)								
	LEAKAGE CURRENT[ma]	0.5max (60Hz, According to UL, CSA and DEN-AN)								
OUTPUT	VOLTAGE[V]	3	5	12	15	24	24	36	48	
	CURRENT[A]	*3 15	15	6.3	5	3.2	3.2 (Peak 4.2)	2.1	1.6	
	LINE REGULATION[mV]	20max	20max	48max	60max	96max	96max	144max	192max	
	LOAD REGULATION[mV]	40max	40max	100max	120max	150max	150max	240max	300max	
	RIPPLE[mVp-p]	0 to +50°C *1	80max	80max	120max	120max	120max	120max	150max	150max
		-10 - 0°C *1	140max	140max	160max	160max	160max	160max	200max	200max
	RIPPLE NOISE[mVp-p]	0 to +50°C *1	120max	120max	150max	150max	150max	150max	250max	350max
		-10 - 0°C *1	160max	160max	180max	180max	180max	180max	300max	400max
	TEMPERATURE REGULATION[mV]	0 to +50°C	50max	50max	120max	150max	240max	240max	360max	480max
		-10 to +50°C	60max	60max	150max	180max	290max	290max	450max	600max
	DRIFT[mV]	*2 20max	20max	48max	60max	96max	96max	144max	192max	
	START-UP TIME[ms]	200max (ACIN 85V, Io=100%)								
	HOLD-UP TIME[ms]	10typ (ACIN 85V, Io=100%) 20typ (ACIN 100V, Io=100%)								
OUTPUT VOLTAGE ADJUSTMENT RANGE[V]	2.85 - 3.6	Fixed ("Y" which can be adjusted the output is available as optional: 5, 12, 15, 24, 36, 48V ±10%)								
OUTPUT VOLTAGE SETTING[V]	—	4.9 - 5.3	11.5 - 12.5	14.4 - 15.6	23.0 - 25.0	23.0 - 25.0	34.5 - 37.5	46.0 - 50.0		
PROTECTION CIRCUIT AND OTHERS	OVERCURRENT PROTECTION	Works over 105% of rating (works over 105% of peak current at option -H) and recovers automatically								
	OVERVOLTAGE PROTECTION	4.00 - 5.25V	Works at 115 - 140% of rating							
	OPERATING INDICATION	Not provided								
	REMOTE SENSING	Not provided								
ISOLATION	REMOTE ON/OFF	Not provided								
	INPUT-OUTPUT	AC2,000V 1minute, Cutoff current = 10mA, DC500V 50MΩ min (At Room Temperature)								
ISOLATION	INPUT-FG	AC2,000V 1minute, Cutoff current = 10mA, DC500V 50MΩ min (At Room Temperature)								
	OUTPUT-FG	AC500V 1minute, Cutoff current = 100mA, DC500V 50MΩ min (At Room Temperature)								
ENVIRONMENT	OPERATING TEMP., HUMID. AND ALTITUDE	-10 to +60°C, 20 - 90%RH (Non condensing) (Refer to DERATING CURVE), 3,000m (10,000feet) max								
	STORAGE TEMP., HUMID. AND ALTITUDE	-20 to +75°C, 20 - 90%RH (Non condensing), 9,000m (30,000feet) max								
	VIBRATION	10 - 55Hz, 19.6m/s <sup>2</sup> (2G), 3minutes period, 60minutes each along X, Y and Z axis								
SAFETY AND NOISE REGULATIONS	IMPACT	196.1m/s <sup>2</sup> (20G), 11ms, once each X, Y and Z axis								
	AGENCY APPROVALS	UL60950-1, CSA C22.2 No.60950-1 Complies with DEN-AN								
	CONDUCTED NOISE	Complies with FCC-B, VCCI-B								
OTHERS	CASE SIZE/WEIGHT	50 X 32 X 222mm (W X H X D) / 300g max								
	COOLING METHOD	Convection								

\*1 Measured by 20MHz oscilloscope or Ripple-Noise meter (equivalent to KEISOKU-GIKEN : RM101).  
 \*2 Drift is the change in DC output for an eight hour period after a half-hour warm-up at 25°C with the input voltage held constant at the rated input/output.  
 \*3 Peak load for 10 sec. or less is acceptable (The average current has to be less than the rated current).  
 \*4 Please contact us about safety approvals for the model with option.

External view

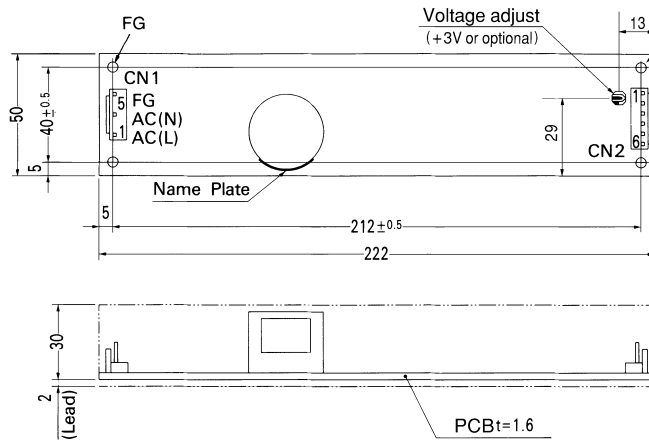

	I/O Connector	Mating Connector	Terminal
Output (-)			
CN1	B3P5-VH	VHR-5N	Chain: SVH-21T-P1.1 Loose: BVH-21T-P1.1
Output (+)			
CN2	B6P-VH	VHR-6N	Chain: SVH-21T-P1.1 Loose: BVH-21T-P1.1

(Mfr.: J.S.T.)

<PIN CONNECTION>

CN1	Pin No.	Input
	1	AC(L)
	2	AC(N)
	3	AC(N)
	4	AC(N)
5	FG	

CN2	Pin No.	Output
	1~3	-V
4~6	+V	

※Maximum 5A per pin of CN2 can be applied.

- ※Weight : 300g or less
- ※Tolerance : ±1
- ※Dimensions in mm.
- ※PCB Material : Glass composite (CEM3)

Performance data

■STATIC CHARACTERISTICS (LCA75S-5)

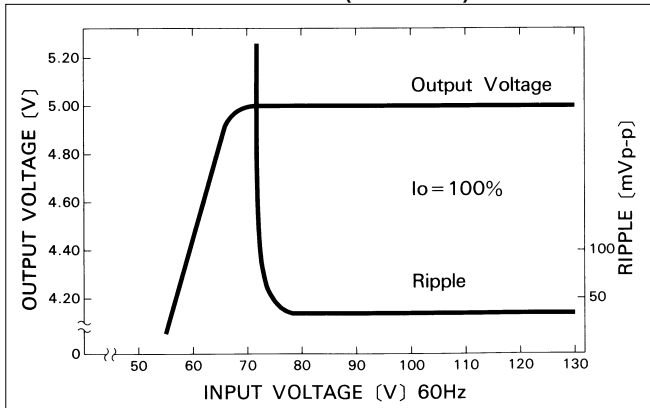

■RISE TIME & FALL TIME (LCA75S-5)

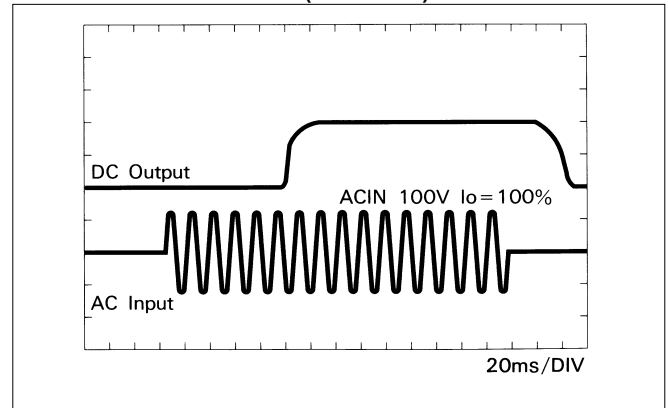

■OVERCURRENT CHARACTERISTICS (LCA75S-5)

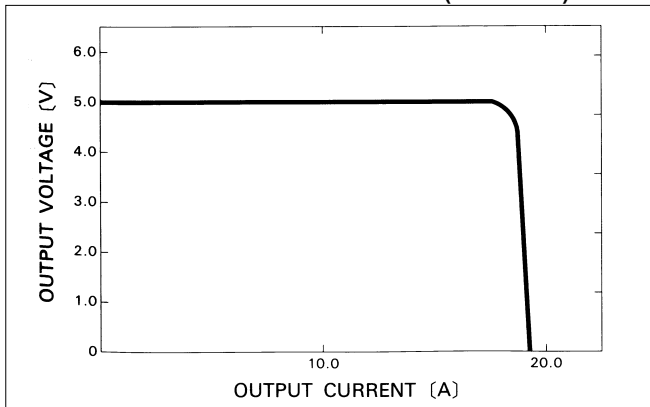

■DERATING CURVE

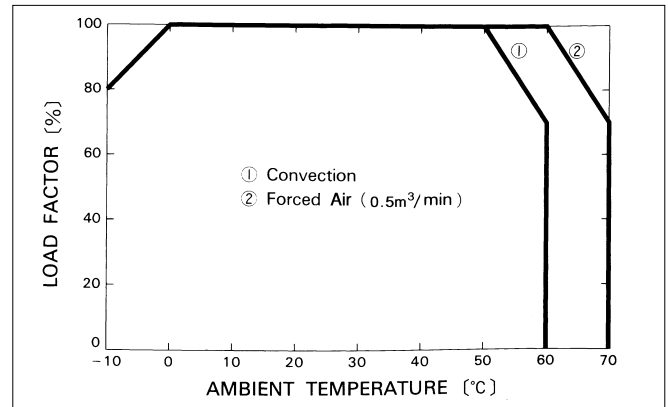

# LCA100S

LC A 100 S -5 -□

① ② ③ ④ ⑤ ⑥



Recommended EMI/EMC Filter  
NAC-06-472



High voltage pulse noise type : NAP series  
Low leakage current type : NAM series  
\*The EMI/EMC Filter is recommended to connect with several devices.

- ① Series name
- ② 100/120V input
- ③ Output wattage
- ④ Single output
- ⑤ Output voltage
- ⑥ Optional \*4
- C :with Coating
- G :Low leakage current
- S :with Chassis
- SN :with Chassis & cover
- Y :with Potentiometer

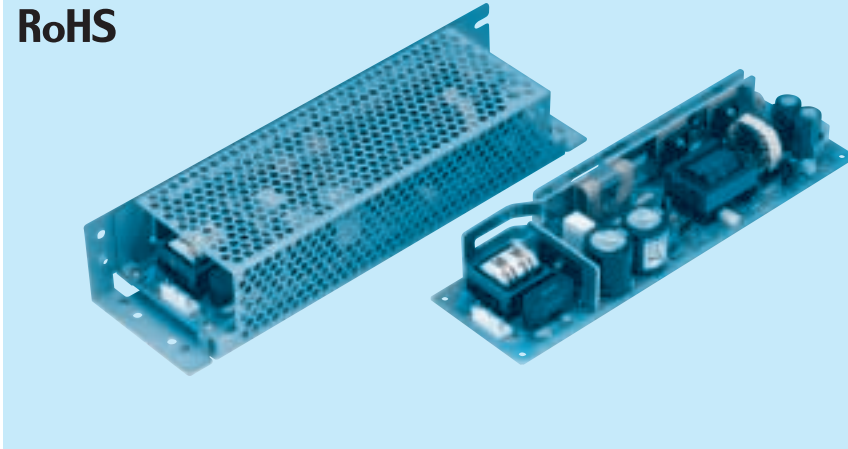

MODEL	LCA100S-3	LCA100S-5	LCA100S-12	LCA100S-15	LCA100S-24	LCA100S-24-H	LCA100S-36	LCA100S-48
MAX OUTPUT WATTAGE[W]	60	100	102	105	103.2	103.2	108	105.6
DC OUTPUT	3V 20A	5V 20A	12V 8.5A	15V 7A	24V 4.3A	24V 4.3A	36V 3A	48V 2.2A

## SPECIFICATIONS

	MODEL	LCA100S-3	LCA100S-5	LCA100S-12	LCA100S-15	LCA100S-24	LCA100S-24-H	LCA100S-36	LCA100S-48	
LCA INPUT	VOLTAGE[V]	AC85 - 132 1 φ or DC110 - 170								
	CURRENT[A]	ACIN 100V 2.5typ (Io=100%)								
	FREQUENCY[Hz]	47 - 440 or DC								
	EFFICIENCY[%]	74typ	79typ	83typ	84typ	85typ	85typ	85typ	85typ	
	INRUSH CURRENT[A]	ACIN 100V 15typ (Io=100%)								
	LEAKAGE CURRENT[ma]	0.5max (60Hz, According to UL, CSA and DEN-AN)								
OUTPUT	VOLTAGE[V]	3	5	12	15	24	24	36	48	
	CURRENT[A]	*3 20	20	8.5	7	4.3	4.3 (Peak 7)	3	2.2	
	LINE REGULATION[mV]	20max	20max	48max	60max	96max	96max	144max	192max	
	LOAD REGULATION[mV]	40max	40max	100max	120max	150max	150max	240max	300max	
	RIPPLE[mVp-p]	0 to +50°C *1	80max	80max	120max	120max	120max	120max	150max	150max
		-10 - 0°C *1	140max	140max	160max	160max	160max	160max	200max	200max
	RIPPLE NOISE[mVp-p]	0 to +50°C *1	120max	120max	150max	150max	150max	250max	250max	350max
		-10 - 0°C *1	160max	160max	180max	180max	180max	280max	300max	400max
	TEMPERATURE REGULATION[mV]	0 to +50°C	50max	50max	120max	150max	240max	240max	360max	480max
		-10 to +50°C	60max	60max	150max	180max	290max	290max	450max	600max
	DRIFT[mV]	*2 20max	20max	48max	60max	96max	96max	144max	192max	
	START-UP TIME[ms]	200max (ACIN 85V, Io=100%)								
	HOLD-UP TIME[ms]	10typ (ACIN 85V, Io=100%) 20typ (ACIN 100V, Io=100%)								
OUTPUT VOLTAGE ADJUSTMENT RANGE[V]	2.85 - 3.6	4.5 - 5.5	Fixed ("Y"which can be adjusted the output is available as optional: 12, 15, 24, 36, 48V ±10%)							
OUTPUT VOLTAGE SETTING[V]	—	—	11.5 - 12.5	14.4 - 15.6	23.0 - 25.0	23.0 - 25.0	34.5 - 37.5	46.0 - 50.0		
PROTECTION CIRCUIT AND OTHERS	OVERCURRENT PROTECTION	Works over 105% of rating (works over 105% of peak current at option -H) and recovers automatically								
	OVERVOLTAGE PROTECTION	4.00 - 5.25V	Works at 115 - 140% of rating							
	OPERATING INDICATION	Not provided								
	REMOTE SENSING	Not provided								
ISOLATION	REMOTE ON/OFF	Not provided								
	INPUT-OUTPUT	AC2,000V 1minute, Cutoff current = 10mA, DC500V 50MΩ min (At Room Temperature)								
ENVIRONMENT	INPUT-FG	AC2,000V 1minute, Cutoff current = 10mA, DC500V 50MΩ min (At Room Temperature)								
	OUTPUT-FG	AC500V 1minute, Cutoff current = 100mA, DC500V 50MΩ min (At Room Temperature)								
SAFETY AND NOISE REGULATIONS	OPERATING TEMP.,HUMID.AND ALTIITUDE	-10 to +60°C, 20 - 90%RH (Non condensing) (Refer to DERATING CURVE), 3,000m (10,000feet) max								
	STORAGE TEMP.,HUMID.AND ALTIITUDE	-20 to +75°C, 20 - 90%RH (Non condensing), 9,000m (30,000feet) max								
	VIBRATION	10 - 55Hz, 19.6m/s <sup>2</sup> (2G), 3minutes period, 60minutes each along X, Y and Z axis								
OTHERS	IMPACT	196.1m/s <sup>2</sup> (20G), 11ms, once each X, Y and Z axis								
	AGENCY APPROVALS	UL60950-1, CSA C22.2 No.60950-1 Complies with DEN-AN								
	CONDUCTED NOISE	Complies with FCC-B, VCCI-B								
OTHERS	CASE SIZE/WEIGHT	62X32X222mm (WxHxD) / 370g max (without chassis and cover)								
	COOLING METHOD	Convection								

\*1 Measured by 20MHz oscilloscope or Ripple-Noise meter(equivalent to KEISOKU-GIKEN : RM101).  
 \*2 Drift is the change in DC output for an eight hour period after a half-hour warm-up at 25°C with the input voltage held constant at the rated input/output.  
 \*3 Peak load for 20 sec. or less is acceptable(The average current has to be less than the rated current).  
 \*4 Please contact us about safety approvals for the model with option.  
 \* Derating is required when operated with chassis and cover.

## External view

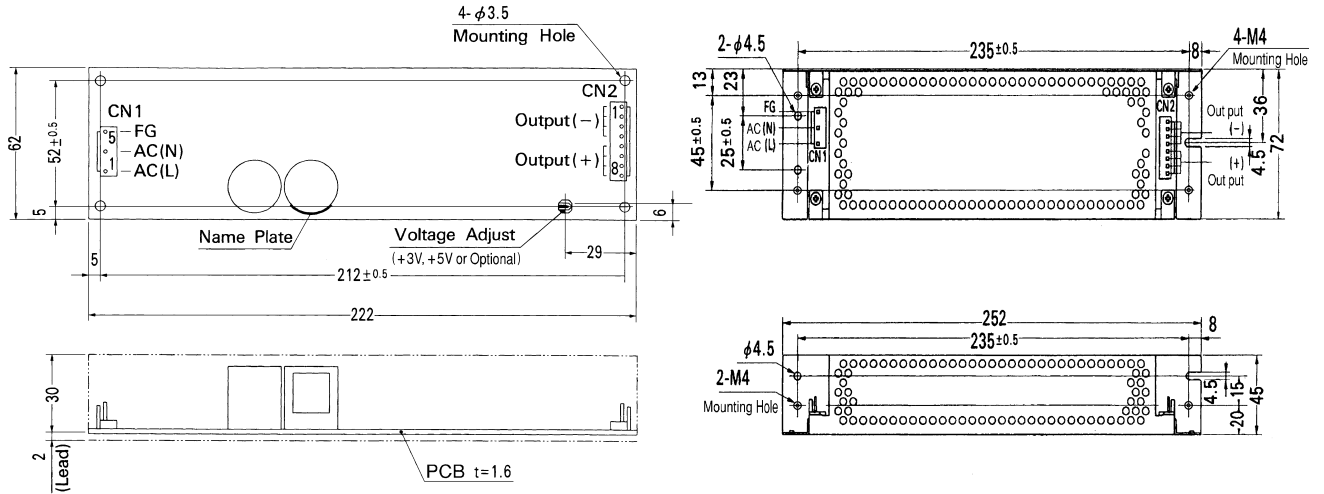

<PIN CONNECTION>

I/O Connector	Mating Connector	Terminal
CN1	B3P5-VH	VHR-5N
		Chain: SVH-21T-P1.1
		Loose: BVH-21T-P1.1
CN2	B8P-VH	VHR-8N
		Chain: SVH-21T-P1.1
		Loose: BVH-21T-P1.1

(Mfr.: J.S.T.)

Pin No.	Input
1	AC(L)
2	
3	AC(N)
4	
5	FG

Pin No.	Output
1~4	-V
5~8	+V

※ Maximum 5A per pin of CN2 can be applied.

- ※ Weight : 370g or less (without chassis and cover)
- ※ Tolerance : ± 1
- ※ Dimensions in mm.
- ※ PCB Material : Glass composite (CEM3)
- ※ Chassis and cover is optional
- ※ Mounting torque : 1.5N·m (16kgf·cm) max

## Performance data

### ■ STATIC CHARACTERISTICS (LCA100S-5)

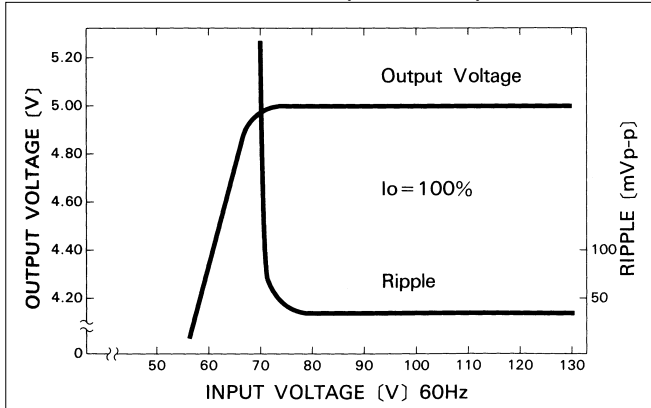

### ■ RISE TIME & FALL TIME (LCA100S-5)

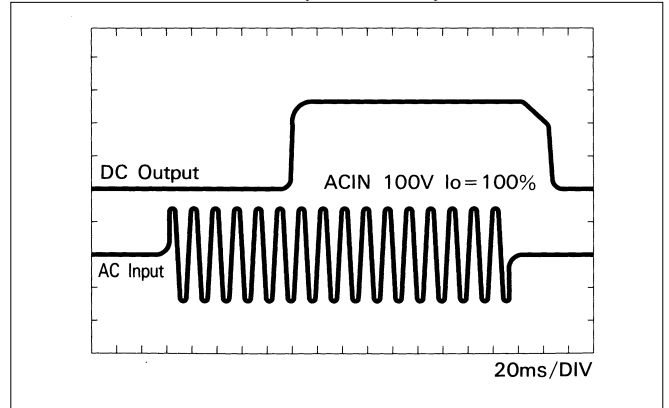

### ■ OVERCURRENT CHARACTERISTICS (LCA100S-5)

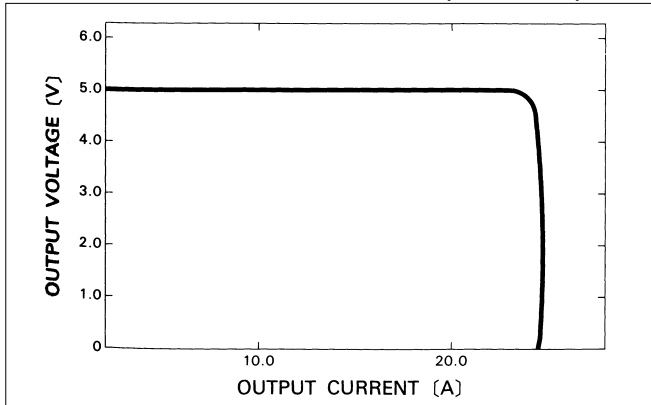

### ■ DERATING CURVE

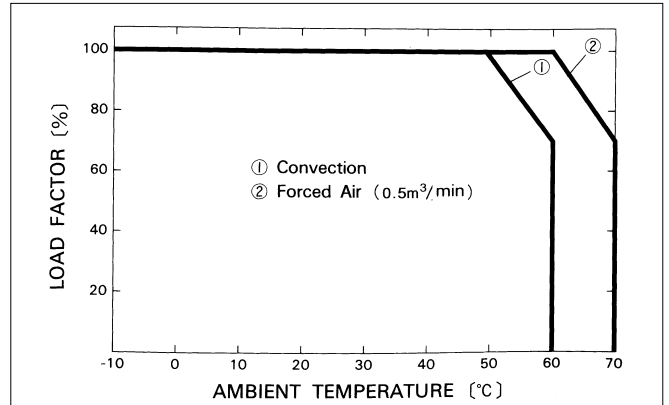

# LCA150S

LC A 150 S -5 -□

① ② ③ ④ ⑤ ⑥



RoHS

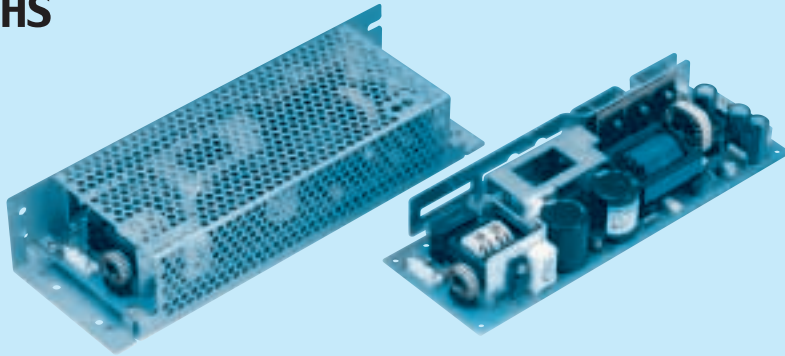

Recommended EMI/EMC Filter  
NAC-06-472



High voltage pulse noise type : NAP series  
Low leakage current type : NAM series  
\*The EMI/EMC Filter is recommended to connect with several devices.

- ① Series name
- ② 100/120V input
- ③ Output wattage
- ④ Single output
- ⑤ Output voltage
- ⑥ Optional \*4
- C :with Coating
- G :Low leakage current
- S :with Chassis
- SN :with Chassis & cover
- Y :with Potentiometer

MODEL	LCA150S-3	LCA150S-5	LCA150S-12	LCA150S-15	LCA150S-24	LCA150S-24-H	LCA150S-36	LCA150S-48
MAX OUTPUT WATTAGE[W]	90	150	150	150	151.2	151.2	151.2	153.6
DC OUTPUT	3V 30A	5V 30A	12V 12.5A	15V 10A	24V 6.3A	24V 6.3A	36V 4.2A	48V 3.2A

## SPECIFICATIONS

	MODEL	LCA150S-3	LCA150S-5	LCA150S-12	LCA150S-15	LCA150S-24	LCA150S-24-H	LCA150S-36	LCA150S-48	
LCA INPUT	MODEL	AC85 - 132 1 φ or DC110 - 170								
	VOLTAGE[V]	AC85 - 132 1 φ or DC110 - 170								
	CURRENT[A]	ACIN 100V 3.6typ (Io=100%)								
	FREQUENCY[Hz]	47 - 440 or DC								
	EFFICIENCY[%]	72typ	79typ	82typ	83typ	85typ	85typ	85typ	85typ	
	INRUSH CURRENT[A]	ACIN 100V 15typ (Io=100%)								
OUTPUT	LEAKAGE CURRENT[ma]	0.5max (60Hz, According to UL, CSA and DEN-AN)								
	VOLTAGE[V]	3	5	12	15	24	24	36	48	
	CURRENT[A]	*3 30	30	12.5	10	6.3	6.3 (Peak 10)	4.2	3.2	
	LINE REGULATION[mV]	20max	20max	48max	60max	96max	96max	144max	192max	
	LOAD REGULATION[mV]	40max	40max	100max	120max	150max	150max	240max	300max	
	RIPPLE[mVp-p]	0 to +50°C *1	80max	80max	120max	120max	120max	120max	150max	150max
		-10 - 0°C *1	140max	140max	160max	160max	160max	160max	200max	200max
	RIPPLE NOISE[mVp-p]	0 to +50°C *1	120max	120max	150max	150max	150max	150max	250max	350max
		-10 - 0°C *1	160max	160max	180max	180max	180max	180max	300max	400max
	TEMPERATURE REGULATION[mV]	0 to +50°C	50max	50max	120max	150max	240max	240max	360max	480max
		-10 to +50°C	60max	60max	150max	180max	290max	290max	450max	600max
	DRIFT[mV]	*2 20max	20max	48max	60max	96max	96max	144max	192max	
	START-UP TIME[ms]	200max (ACIN 85V, Io=100%)								
	HOLD-UP TIME[ms]	10typ (ACIN 85V, Io=100%) 20typ (ACIN 100V, Io=100%)								
	OUTPUT VOLTAGE ADJUSTMENT RANGE[V]	2.85 - 3.6	4.5 - 5.5	Fixed ("Y"which can be adjusted the output is available as optional: 12, 15, 24, 36, 48V ±10%)						
OUTPUT VOLTAGE SETTING[V]	—	—	11.5 - 12.5	14.4 - 15.6	23.0 - 25.0	23.0 - 25.0	34.5 - 37.5	46.0 - 50.0		
PROTECTION CIRCUIT AND OTHERS	OVERCURRENT PROTECTION	Works over 105% of rating (works over 105% of peak current at option -H) and recovers automatically								
	OVERVOLTAGE PROTECTION	4.00 - 5.25V		Works at 115 - 140% of rating						
	OPERATING INDICATION	Not provided								
	REMOTE SENSING	Not provided								
ISOLATION	REMOTE ON/OFF	Not provided								
	INPUT-OUTPUT	AC2,000V 1minute, Cutoff current = 10mA, DC500V 50MΩ min (At Room Temperature)								
	INPUT-FG	AC2,000V 1minute, Cutoff current = 10mA, DC500V 50MΩ min (At Room Temperature)								
ENVIRONMENT	OUTPUT-FG	AC500V 1minute, Cutoff current = 100mA, DC500V 50MΩ min (At Room Temperature)								
	OPERATING TEMP., HUMID. AND ALTITUDE	-10 to +60°C, 20 - 90%RH (Non condensing) (Refer to DERATING CURVE), 3,000m (10,000feet) max								
	STORAGE TEMP., HUMID. AND ALTITUDE	-20 to +75°C, 20 - 90%RH (Non condensing), 9,000m (30,000feet) max								
	VIBRATION	10 - 55Hz, 19.6m/s <sup>2</sup> (2G), 3minutes period, 60minutes each along X, Y and Z axis								
SAFETY AND NOISE REGULATIONS	IMPACT	196.1m/s <sup>2</sup> (20G), 11ms, once each X, Y and Z axis								
	AGENCY APPROVALS	UL60950-1, CSA C22.2 No.60950-1 Complies with DEN-AN								
	CONDUCTED NOISE	Complies with FCC-B, VCCI-B								
OTHERS	CASE SIZE/WEIGHT	75 X 36 X 222mm (W X H X D) / 550g max (without chassis and cover)								
	COOLING METHOD	Convection								

\*1 Measured by 20MHz oscilloscope or Ripple-Noise meter (equivalent to KEISOKU-GIKEN : RM101).  
 \*2 Drift is the change in DC output for an eight hour period after a half-hour warm-up at 25°C with the input voltage held constant at the rated input/output.  
 \*3 Peak load for 15 sec. or less is acceptable (The average current has to be less than the rated current).  
 \*4 Please contact us about safety approvals for the model with option.  
 \* Derating is required when operated with chassis and cover.

## External view

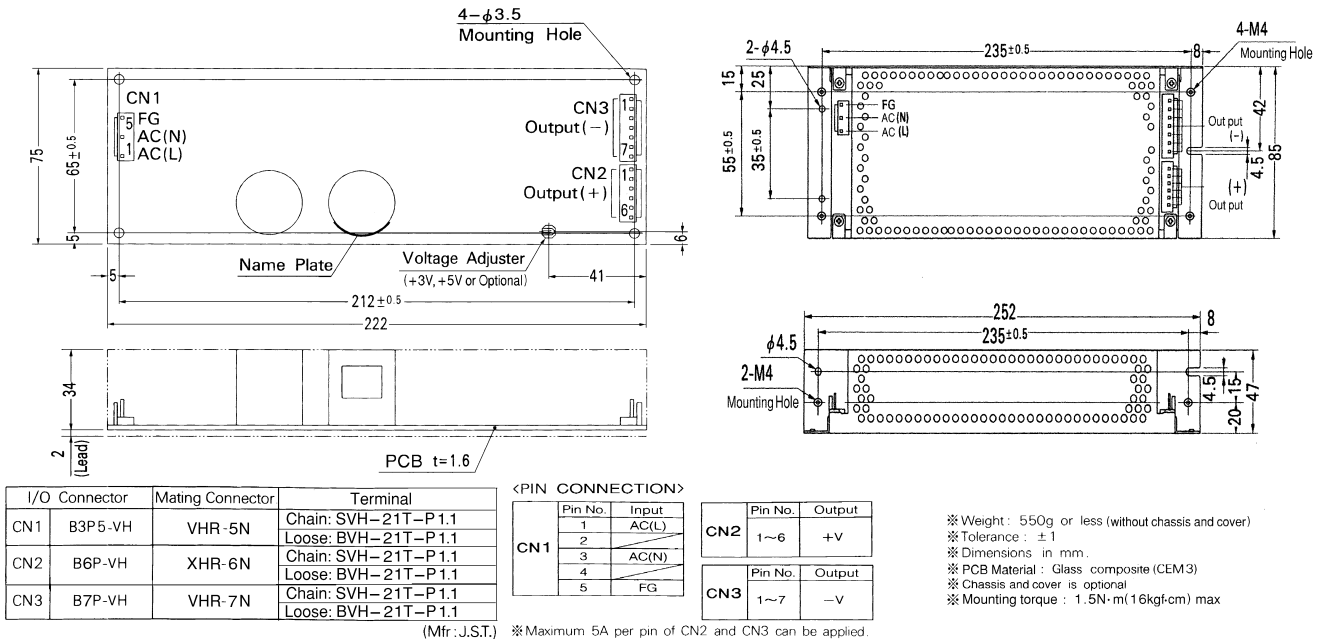

## Performance data

### ■ STATIC CHARACTERISTICS (LCA150S-5)

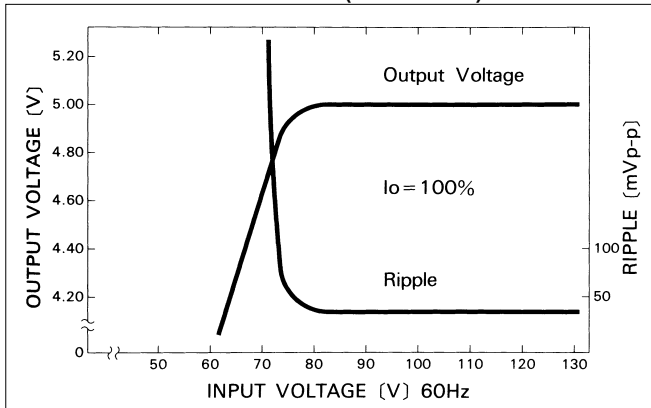

### ■ RISE TIME & FALL TIME (LCA150S-5)

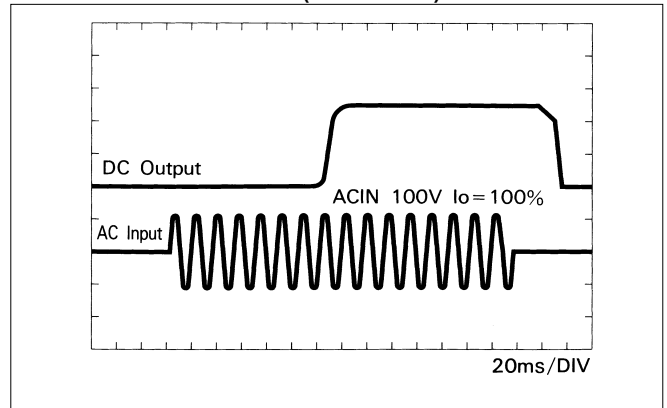

### ■ OVERCURRENT CHARACTERISTICS (LCA150S-5)

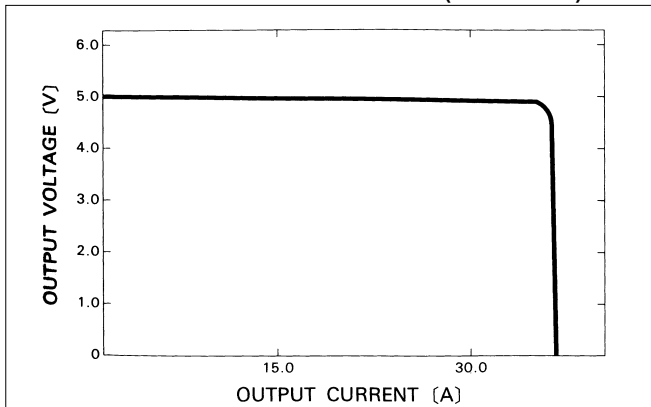

### ■ DERATING CURVE

