

## Basic Characteristics Data

Model	Circuit method	Switching frequency [kHz]	Input current [A]	Rated input fuse	Inrush current protection	PCB/Pattern			Series/Parallel operation availability	
						Material	Single sided	Double sided	Series operation	Parallel operation
ZUS1R5	Flyback converter	310 - 1600	*1	Refer to table No.1	-	glass fabric base.epoxy resin		Yes	*2	*2
ZUS3	Flyback converter	200 - 1600	*1	Refer to table No.1	-	glass fabric base.epoxy resin		Yes	*2	*2
ZUS6	Flyback converter	150 - 1600	*1	Refer to table No.1	-	glass fabric base.epoxy resin		Yes	*2	*2
ZUS10	Flyback converter	130 - 200	*1	Refer to table No.1	-	glass fabric base.epoxy resin		Yes	Yes	*2
ZUS15	Single ended forward converter	330 - 400	*1	Refer to table No.1	-	glass fabric base.epoxy resin		Yes	Yes	*2
ZUS25	Single ended forward converter	330 - 400	*1	Refer to table No.1	-	glass fabric base.epoxy resin		Yes	Yes	*2
ZTS1R5	Flyback converter	310 - 1600	*1	Refer to table No.1	-	glass fabric base.epoxy resin		Yes	*2	*2
ZTS3	Flyback converter	200 - 1600	*1	Refer to table No.1	-	glass fabric base.epoxy resin		Yes	*2	*2
ZUW1R5	Flyback converter	310 - 1600	*1	Refer to table No.1	-	glass fabric base.epoxy resin		Yes	*2	*2
ZUW3	Flyback converter	200 - 1600	*1	Refer to table No.1	-	glass fabric base.epoxy resin		Yes	*2	*2
ZUW6	Flyback converter	150 - 1600	*1	Refer to table No.1	-	glass fabric base.epoxy resin		Yes	*2	*2
ZUW10	Flyback converter	130 - 200	*1	Refer to table No.1	-	glass fabric base.epoxy resin		Yes	Yes	*2
ZUW15	Single ended forward converter	330 - 400	*1	Refer to table No.1	-	glass fabric base.epoxy resin		Yes	Yes	*2
ZUW25	Single ended forward converter	330 - 400	*1	Refer to table No.1	-	glass fabric base.epoxy resin		Yes	Yes	*2
ZTW1R5	Flyback converter	310 - 1600	*1	Refer to table No.1	-	glass fabric base.epoxy resin		Yes	*2	*2
ZTW3	Flyback converter	200 - 1600	*1	Refer to table No.1	-	glass fabric base.epoxy resin		Yes	*2	*2

\*1 Refer to Specification.

\*2 Refer to Instruction Manual.

Table1. Rated input fuse

Output Power	Input Voltage			
	5V	12V	24V	48V
1.5W	72V 1.2A	72V 0.8A	72V 0.8A	72V 1.2A
3W	72V 2.0A	72V 1.2A	72V 1.2A	72V 1.2A
6W	72V 4.0A	72V 2.0A	72V 2.0A	72V 1.2A
10W	125V 6.3A	125V 3.5A	125V 2.0A	125V 1.0A
15W	125V 8.0A	125V 5.0A	72V 4.0A	72V 4.0A
25W	125V 10.0A	125V 6.3A	125V 3.15A	125V 2.0A

ZU/ZT

## ZU1R5 · ZU3 · ZU6 · ZU10

<b>1</b>	Pin Connection	ZU/ZT-36
<b>2</b>	Function	ZU/ZT-36
2.1	Input voltage	ZU/ZT-36
2.2	Overcurrent protection	ZU/ZT-36
2.3	Isolation	ZU/ZT-36
<b>3</b>	Wiring to Input/Output Pin	ZU/ZT-36
<b>4</b>	Series Operation and Parallel Operation	ZU/ZT-37
4.1	Series operation	ZU/ZT-37
4.2	Redundancy operation	ZU/ZT-38
<b>5</b>	Assembling and Installation Method	ZU/ZT-38
5.1	Installation method	ZU/ZT-38
5.2	Derating	ZU/ZT-38
<b>6</b>	Input Voltage/Current Range	ZU/ZT-39
<b>7</b>	Cleaning	ZU/ZT-39
<b>8</b>	Soldering	ZU/ZT-39
<b>9</b>	Input/Output Pin	ZU/ZT-39
<b>10</b>	Peak Current (Pulse Load)	ZU/ZT-39

## ZU15 · ZU25

<b>1</b>	Pin Connection	ZU/ZT-40
<b>2</b>	Function	ZU/ZT-40
2.1	Input voltage	ZU/ZT-40
2.2	Overcurrent protection	ZU/ZT-40
2.3	Overvoltage protection	ZU/ZT-41
2.4	Adjustable voltage range	ZU/ZT-41
2.5	Remote ON/OFF	ZU/ZT-41
2.6	Isolation	ZU/ZT-41
<b>3</b>	Wiring to Input/Output Pin	ZU/ZT-42
<b>4</b>	Series Operation and Parallel Operation	ZU/ZT-42
4.1	Series operation	ZU/ZT-42
4.2	Redundancy operation	ZU/ZT-42
<b>5</b>	Assembling and Installation Method	ZU/ZT-43
5.1	Installation method	ZU/ZT-43
5.2	Derating	ZU/ZT-43
<b>6</b>	Input Voltage/Current Range	ZU/ZT-44
<b>7</b>	Cleaning	ZU/ZT-44
<b>8</b>	Soldering	ZU/ZT-44
<b>9</b>	Input/Output Pin	ZU/ZT-44
<b>10</b>	Peak Current (Pulse Load)	ZU/ZT-45

## ZT1R5 · ZT3

<b>1</b>	Pin Connection	ZU/ZT-45
<b>2</b>	Function	ZU/ZT-45
2.1	Input voltage	ZU/ZT-45
2.2	Overcurrent protection	ZU/ZT-46
2.3	Isolation	ZU/ZT-46
<b>3</b>	Wiring to Input/Output Pin	ZU/ZT-46
<b>4</b>	Series Operation and Parallel Operation	ZU/ZT-47
4.1	Series operation	ZU/ZT-47
4.2	Redundancy operation	ZU/ZT-47
<b>5</b>	Assembling and Installation Method	ZU/ZT-47
5.1	Installation method	ZU/ZT-47
5.2	Derating	ZU/ZT-47
<b>6</b>	Input Voltage/Current Range	ZU/ZT-47
<b>7</b>	Cleaning	ZU/ZT-48
<b>8</b>	Soldering	ZU/ZT-48
<b>9</b>	Input/Output Pin	ZU/ZT-48
<b>10</b>	Peak Current (Pulse Load)	ZU/ZT-48

ZU1R5 · ZU3 · ZU6 · ZU10

# 1 Pin Connection

No.	Pin connection	Function
①	+DC INPUT	+Side of input voltage
②	-DC INPUT	-Side of input voltage
③	+DC OUTPUT	+Side of output voltage
④	COMMON	GND of output voltage (Only applicable for Dual output)
⑤	-DC OUTPUT	-Side of output voltage
⑥	Case connecting pin	If connected to -side of input, the case potential can be fixed and the value of radiation noise can be reduced.

## ●Single Output

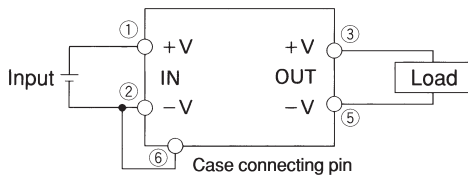

## ●Dual(±)Output

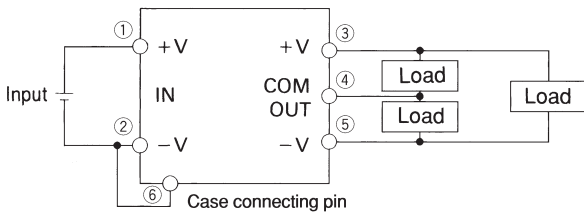

### ●connecting pin

Case connecting pin is available. By connecting this pin to -side of input, the radiation noise from main body can be reduced.

# 2 Function

## 2.1 Input voltage

■If the wrong input is applied, the unit will not operate properly and/or may be damaged.

## 2.2 Overcurrent protection

■Overcurrent protection circuit is built-in and comes into effect at over 105% of the rated current.

Overcurrent protection prevents the unit from short circuit and over current condition of less than 20 sec. The unit automatically recovers when the fault condition is cleared.

■The power supply which has a current foldback characteristics may not start up when connected to nonlinear load such as lamp, motor or constant current load. See the characteristics below.

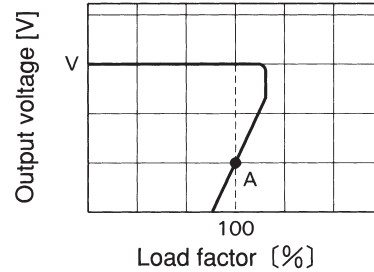

—: Load characteristics of power supply.

-----: Characteristics of load (lamp, motor, constant current load, etc.).

Note: In case of nonlinear load, the output is locked out at A point.

Fig.2.1 Current foldback characteristics

## 2.3 Isolation

■For a receiving inspection, such as Hi-Pot test, gradually increase (decrease) the voltage for the start (shut down). Avoid using Hi-Pot tester with the timer because it may generate voltage a few times higher than the applied voltage, at ON/OFF of a timer.

# 3 Wiring to Input/Output Pin

■Input filter is built-in. A capacitor Ci, if installed near the input terminal, will lower the input conducted noise from converter due to the formation of the π type filter.

■When the distance from the DC line to the unit is greatly extended, it makes the input feedback noise much higher and the input voltage several times higher than the normal level when turned ON. If this happens, the output power also becomes unstable. In order to prevent the unit from failing in this way; please connect Ci to the input terminal. In addition, when the filter with "L" is used, please Ci to the input terminal.

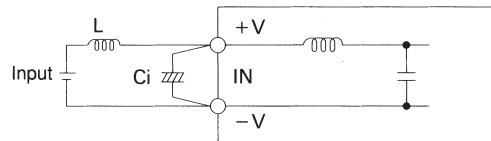

Fig.3.1 Connecting method of capacitor at input terminal

Capacity of external capacitor at input terminal: Ci [μF]

Model	ZUS1R5	ZUS3	ZUS6	ZUS10
Input voltage(V)	ZUW1R5	ZUW3	ZUW6	ZUW10
3, 5	100	220	470	470
12	47	100	220	220
24	33	47	100	100
48	10	22	47	47

ZU1R5 · ZU3 · ZU6 · ZU10

■To lower the output ripple voltage further, install an external capacitor  $C_o$  at output terminal as shown below.

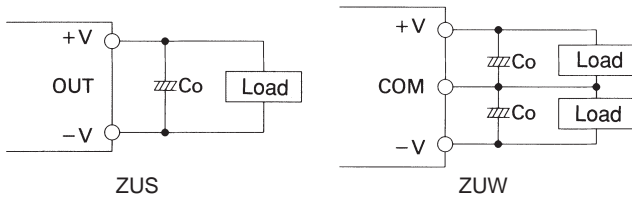

Fig.3.2 Connecting method of external capacitor at output terminal

Capacity of external capacitor at output terminal:  $C_o$  [ $\mu$ F]

Model	ZUS1R5	ZUS3	ZUS6	ZUS10
Output voltage(V)	ZUW1R5	ZUW3	ZUW6	ZUW10
3, 5	100	220	220	220
12	100	100	100	100
15	100	100	100	100

■When the distance between load and DC output is long, please install capacitor at load as shown below.

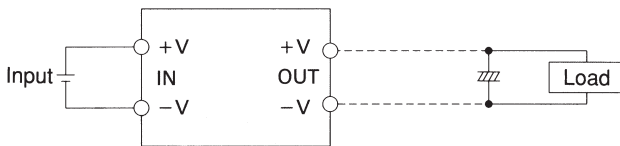

Fig.3.3 Connection method of capacitor at load

Reverse input voltage protection

■Avoid the reverse polarity input voltage. It will damage the power supply.

It is possible to protect the unit from the reverse input voltage by installing an external diode as shown in Fig.3.4.

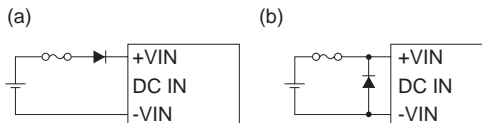

Fig.3.4 Reverse input voltage protection

## 4 Series Operation and Parallel Operation

### 4.1 Series operation

#### ●ZUS1R5/ZUW1R5 · ZUS3/ZUW3 · ZUS6/ZUW6

■Series operation is available by connecting the outputs of two or more power supplies, as shown below. Output currents in series connection should be lower than the lowest rated current in each unit.

But at series operation with same output voltage, diode is not required to attach even if at (a).

(a) When the output voltage is less than 5V.

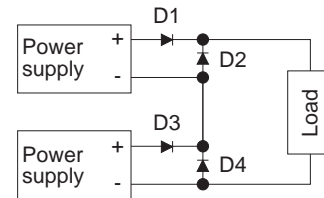

D1 - D4: Please use Schottky Barrier Diode.

(b) When the output voltage is more than 12V.

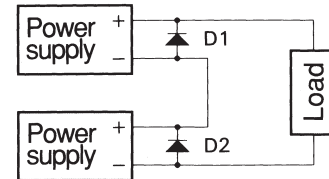

D1 · D2: Please use Schottky Barrier Diode.

#### ●ZUS10/ZUW10

■Series operation is available by connecting the outputs of two or more power supplies as shown below. Output currents in series connection should be lower than the lowest rated current in each unit.

(c)

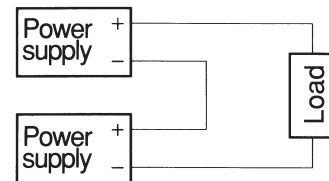

(d)

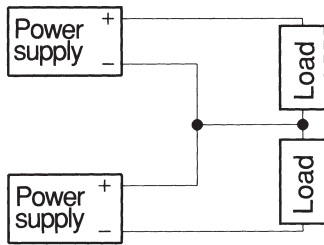

### 4.2 Redundancy operation

Redundancy operation is available by connecting the units as shown below.

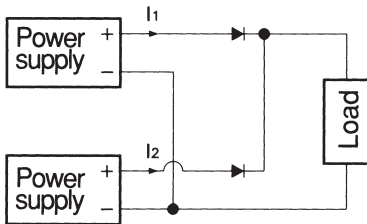

## 5 Assembling and Installation Method

### 5.1 Installation method

- The unit can be mounted in any direction. Position them with proper intervals to allow enough air ventilation. Ambient temperature around each power supply should not exceed the temperature range shown in derating curve.
- Avoid placing the DC input line pattern lay out underneath the unit because it will increase the line conducted noise. Make sure to leave an ample distance between the line pattern lay out and the unit. Also, avoid placing the DC output line pattern underneath the unit because it may increase the output noise. Lay out the pattern away from the unit.

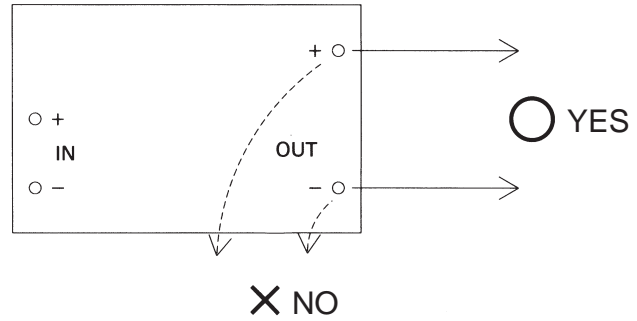
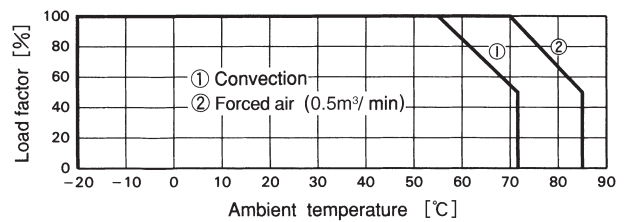

Fig.5.1 Pattern wiring

### 5.2 Derating

- By derating the output current, it is possible to operate the unit from  $-20^{\circ}\text{C}$  to  $+71^{\circ}\text{C}$  ( $-20^{\circ}\text{C}$  to  $+85^{\circ}\text{C}$  at forced air cooling).
- When unit mounted any way other than in drawings below, it is required to consider ventilated environments by forced air cooling or temperature/load derating. For details, please consult our sales or engineering department.
- It is necessary to note thermal fatigue life by power cycle. Please reduce the temperature fluctuation range as much as possible when the up and down of temperature are frequently generated.



## 6 Input Voltage/Current Range

- When a non-regulated source is used as a front end, make sure that the voltage fluctuation together with the ripple voltage will not exceed the input voltage range.
- Select the converter that is able to handle the start-up current ( $I_p$ ).

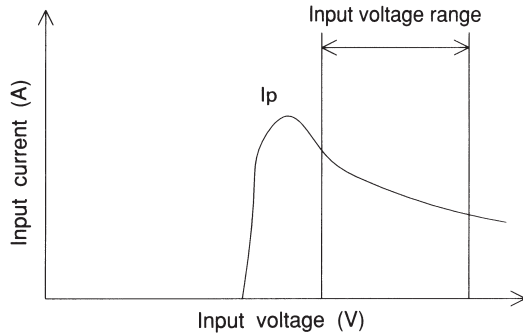

Fig.6.1 Input current characteristics

## 7 Cleaning

- Cleaning is possible by below listed conditions.

Cleaning method

No.	Classification	Cleaning agents
1	Water type	Pine Alpha ST-100S(ARAKAWA CHEMICAL CO.)
2		Clean Through 750H(KAO Corporation)
3	Solvent type	IPA
4		Asahiklin AK-225AES(ASAHI GLASS CO.)

No.	Cleaning method	Liquid Temp.	Period
1	Varnishing or Ultra sonic wave	Less than 60°C	Within 5 minutes
3	Varnishing, Ultra sonic wave, Vapor	-	Within 2 minutes

- During cleaning to drying (the condition that cleaning liquid is soaked into the ink of name plate), do not touch on the surface of name plate.
- After cleaning, dry them enough.

## 8 Soldering

- Flow soldering : 260°C less than 15 seconds.
- Soldering iron : 450°C less than 5 seconds.

## 9 Input/Output Pin

- When too much stress is applied on the input/output pins of the unit, the internal connection may be weakened. As below Fig. 9.1, avoid applying stress of more than 19.6N (2kgf) on the pins horizontally and more than 39.2N (4kgf) vertically.
- The input/output pins are soldered on PCB internally, therefore, do not pull or bend them with abnormal forces.
- When additional stress is expected to be put on the input/output pins because of vibration or impacts, fix the unit on PCB (using silicone rubber or fixing fittings) to reduce the stress onto the input/output pins.

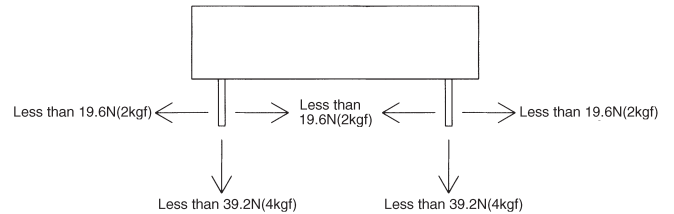
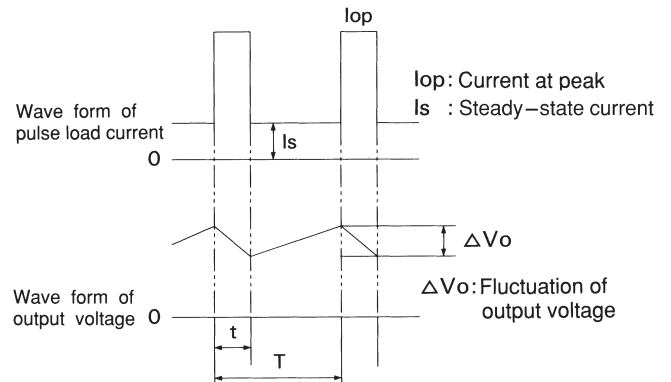
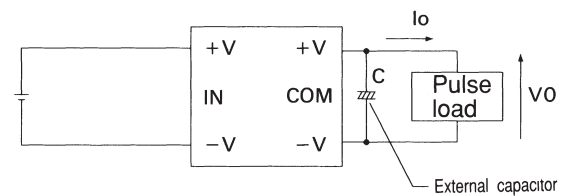

Fig.9.1 Stress onto the pins

## 10 Peak Current (Pulse Load)

- It is possible to supply the pulse current for the pulse load by connecting the capacitor externally at the output side.



# 1 Pin Connection

■The average current  $I_{av}$  of output is shown in below formula.

$$I_{av} = I_s + \frac{(I_{op} - I_s) t}{T}$$

■The required electrolytic capacitor C is found by below formula.

$$C = \frac{(I_{op} - I_{av}) t}{\Delta V_o}$$

No.	Pin connection	Function
①	+DC INPUT	+Side of input voltage
②	-DC INPUT	-Side of input voltage
③	RC	Remote ON/OFF
④	+DC OUTPUT	+Side of output voltage
⑤	COMMON	GND of output voltage (Only applicable for Dual output)
⑥	-DC OUTPUT	-Side of output voltage
⑦	TRM	Adjustment voltage range

## ●Single Output

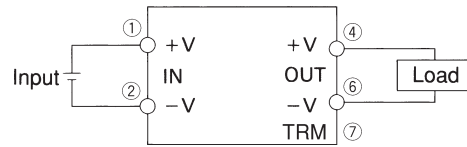

## ●Dual (±) Output

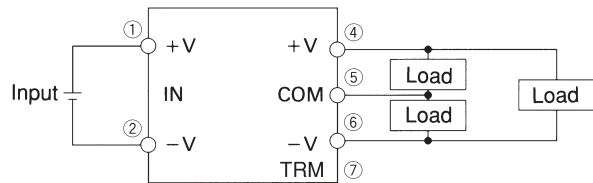

# 2 Function

## 2.1 Input voltage

■If the wrong input is applied, the unit will not operate properly and/or may be damaged.

## 2.2 Overcurrent protection

■Overcurrent protection circuit is built-in and comes into effect at over 105% of the rated current.

Overcurrent protection prevents the unit from short circuit and over current condition of less than 20 sec.

The unit automatically recovers when the fault condition is cleared.

ZU15 · ZU25

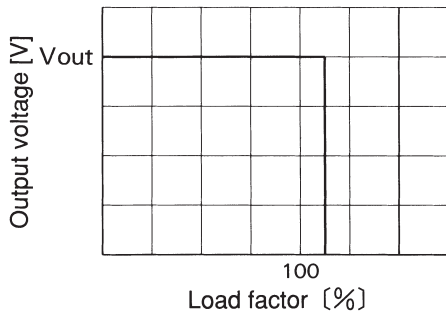

Fig.2.1 Overcurrent protection characteristics

2.3 Overvoltage protection

●Single Output

- The overvoltage protection circuit is built-in and comes into effect at 115 - 140% of the rated voltage. The DC input voltage should be shut down if overvoltage protection is in operation. The minimum interval of DC recycling for recovery 2 to 3 minutes (★).
- ★ The recovery time depends on input voltage.

●Multiple Output

- By detecting overvoltage condition between +V and -V, overvoltage protection circuit comes into effect at 115 - 140% of the rated voltage. The DC input voltage should be shut down if overvoltage protection is in operation. The minimum interval of DC recycling for recovery 2 to 3 minutes (★).
- ★ The recovery time depends on input voltage.

Remarks:

Please note that unit's internal components may be damaged if excessive voltage (over rated voltage) is applied to output terminal of power supply. This could happen when the customer tests the overvoltage performance of the unit.

2.4 Adjustable voltage range

- The output voltage is adjustable by external potentiometer.
- When the output voltage adjustment is not used, open the TRM pin.
- The over voltage protection circuit comes into effect when the output voltage is set too high.
- Output voltage is increased by turning potentiometer clockwise and is decreased by turning potentiometer counterclockwise.
- The wiring to the potentiometer should be as short as possible and connected to the remote sensing pins (+S and -S). The temperature coefficient varies depending on the type of resistor and potentiometer. It is recommended that the following types be used.  
Resistor.....Metal film type, coefficient of less than ±100ppm/°C  
Potentiometer..Cermet type, coefficient of less than ±300ppm/°C

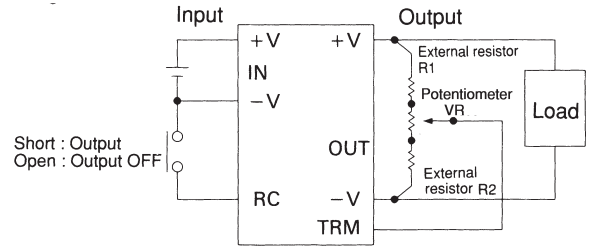

Fig.2.2 Connection devices outside the power supply

Table 2.1 Devices outside the power supply (Adjustable ±5%)

No.	Output voltage	The constant value of devices outside the power supply (Unit: Ω)		
		VR	R1	R2
1	3V	1K	470	150
2	5V	1K	100	270
3	12V	5K	270	2.7K
4	±12V	5K	10K	3.9K
5	±15V	5K	10K	2.7K

2.5 Remote ON/OFF

- The ground terminal of remote ON/OFF circuit is connected with -V input terminal.
- Between RC and -V input: Output voltage is ON at "Low" level or short circuit (0 - 1.2V)
- Between RC and -V input: Output voltage is OFF at "High" level or open circuit (2.4 - 5.5V)

(Connection example)

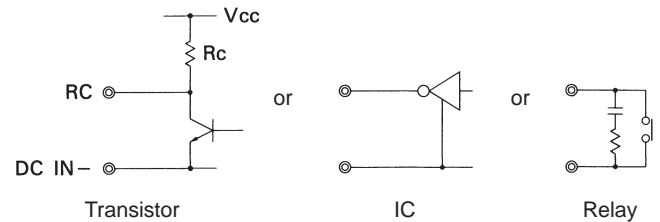

When RC terminal is "Low" level, fan out current is 1mA typ.  
When Vcc is applied, use  $5V \leq V_{cc} \leq 24V$ . When remote ON/OFF function is not used, please short between RC and -V input.

2.6 Isolation

- For a receiving inspection, such as Hi-Pot test, gradually increase (decrease) the voltage for the start (shut down). Avoid using Hi-Pot tester with the timer because it may generate voltage a few times higher than the applied voltage, at ON/OFF of a timer.



### 3 Wiring to Input/Output Pin

- The input filter is built-in. A capacitor (Ci), if installed near the input terminal, will lower the input conducted noise from converter due to the formation of the  $\pi$  type filter.
- When the distance from the DC line to the unit is greatly extended, it makes the input feedback noise much higher and the input voltage several times higher than the normal level when turned ON. In order to prevent the unit from failing in this way; please connect Ci to the input terminal. In addition, when the filter with "L" is used, please connect Ci to the input terminal.

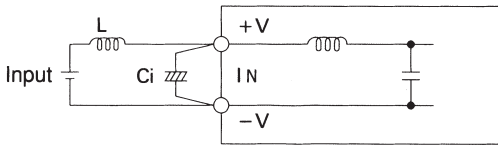

Fig.3.1 Connection method of capacitor at input terminal

Capacity of external capacitor at input terminal: Ci [μF]

Model Input voltage (V)	ZUS15 ZUW15	ZUS25 ZUW25
3, 5	330	470
12	150	220
24	68	100
48	33	47

- To decrease the ripple voltage further, install an external capacitor Co at output terminal as shown below.

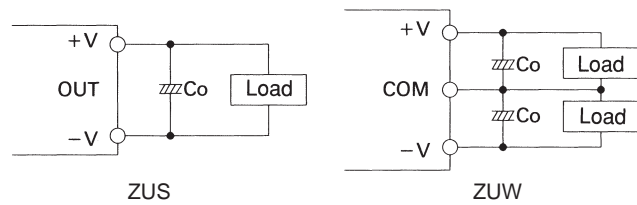

Fig.3.2 Connecting method of external capacitor at output terminal

Capacity of external capacitor at output terminal: Co [μF]

Model Output voltage (V)	ZUS15 ZUW15	ZUS25 ZUW25
3, 5	220	220
12	100	100
15	100	100

### ZU15 · ZU25

- When the distance between load and DC output is long, please install capacitor at load as below.

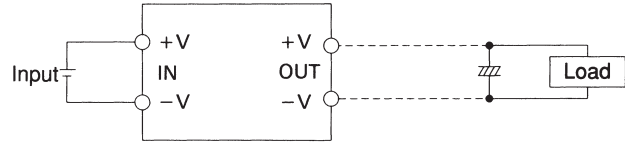

Fig.3.3 Connection method of capacitor at load

#### Reverse input voltage protection

- Avoid the reverse polarity input voltage. It will damage the power supply.
- It is possible to protect the unit from the reverse input voltage by installing an external diode as shown in Fig.3.4.

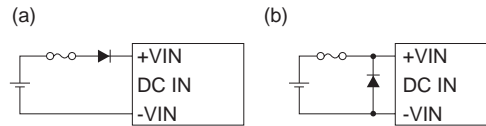
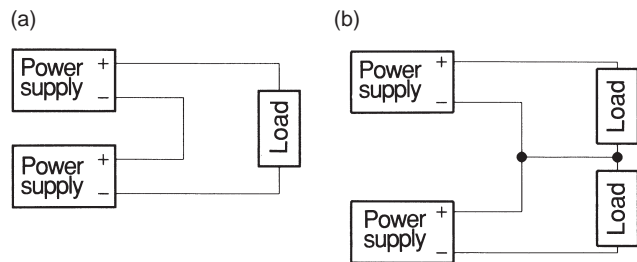

Fig.3.4 Reverse input voltage protection

## 4 Series Operation and Parallel Operation

### 4.1 Series operation

- Series operation is available by connecting the outputs of two or more power supplies, as shown below.
- Output currents in series connection should be lower than the lowest rated current in each unit.



### 4.2 Redundancy operation

- Parallel operation is not possible.
- Redundancy operation is available by wiring as shown below.
- Even a slight difference in output voltage can affect the balance between the values of I1 and I2.
- Please make sure that the value of I3 does not exceed the rated current of a power supply.

$$I_3 \leq \text{the rated current value}$$

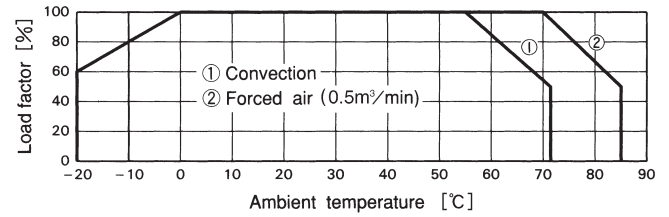
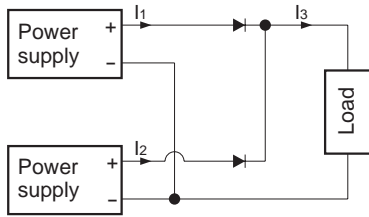

Fig.5.2 Derating curve

## 5 Assembling and Installation Method

### 5.1 Installation method

- The unit can be mounted in any direction. Position them with proper intervals to allow enough air ventilation. Ambient temperature around each power supply should not exceed the temperature range shown in derating curve.
- Avoid placing the DC input line pattern lay out underneath the unit because it will increase the line conducted noise. Make sure to leave an ample distance between the line pattern lay out and the unit. Also, avoid placing the DC output line pattern underneath the unit because it may increase the output noise. Lay out the pattern away from the unit.

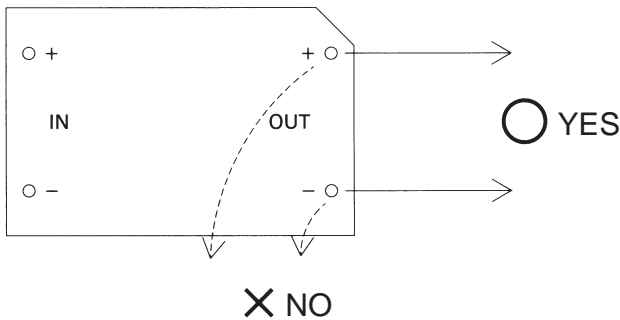

Fig.5.1 Pattern wiring

### 5.2 Derating

- By derating the output current, it is possible to operate the unit from -20°C to +71°C (-20°C to +85°C at forced air cooling).
- When unit mounted any way other than in drawings below, it is required to consider ventilated environments by forced air cooling or temperature/load derating. For details, please consult our sales or engineering departments.
- It is necessary to note thermal fatigue life by power cycle. Please reduce the temperature fluctuation range as much as possible when the up and down of temperature are frequently generated.

ZU15 · ZU25

■The temperature increase of case surface at full load is shown by below table as referenced data.

Temperature increase on surface of case (ZU series) (Unit: deg)

Input Voltage	Output Voltage	15W	25W
5V	5V	30	38
	12V	36	42
	±12V	39	39
	±15V	38	40
12V	5V	28	36
	12V	34	42
	±12V	36	43
	±15V	35	45
24V	5V	31	32
	12V	38	38
	±12V	34	36
	±15V	27	35
48V	5V	21	28
	12V	23	25
	±12V	24	31
	±15V	26	31

## 6 Input Voltage/Current Range

- When a non-regulated source is used as a front end, make sure that the voltage fluctuation together with the ripple voltage will not exceed the input voltage range.
- Select the converter that is able to handle the start-up current (Ip).

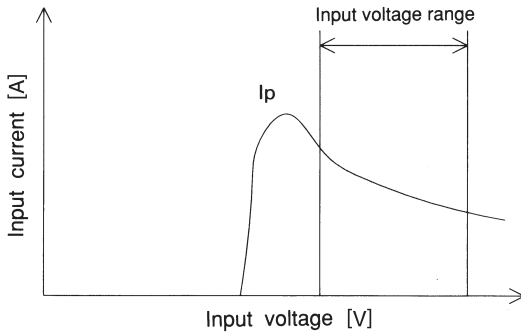

Fig.6.1 Input current characteristics

## 7 Cleaning

■Cleaning agents :

No.	Classification	Cleanig agents
1	Water type	Pine Alpha ST-100S(ARAKAWA CHEMICAL CO.)
2		Clean Through 750H(KAO Corporation)
3	Solvent type	IPA
4		Asahiklin AK-225AES(ASAHI GLASS CO.)

■Cleaning period : The total time of varnishing, ultrasonic wave and vaper should be within 2 minutes. In case of ultrasonic wave cleaning, the ultrasonic should be less than 15kw/m<sup>3</sup>. During cleaning to drying (the condition that cleaning liquid is soaked into the ink of name plate), do not touch on the surface of name plate.

■After cleaning, dry them enough.

## 8 Soldering

■Flow soldering : 260°C less than 15 seconds.

■Soldering iron : 450°C less than 5 seconds.

## 9 Input/Output Pin

- When too much stress is applied on the input/output pins of the unit, the internal connection may be weakened. As below Fig. 9.1, avoid applying stress of more than 19.6N (2kgf) on the pins horizontally and more than 39.2N (4kgf) vertically.
- The input/output pins are soldered on PCB internally, therefore, do not pull or bend them with abnormal forces.
- When additional stress is expected to be put on the input/output pins because of vibration or impacts, fix the unit on PCB (using silicone rubber or fixing fittings) to reduce the stress onto the input/output pins.

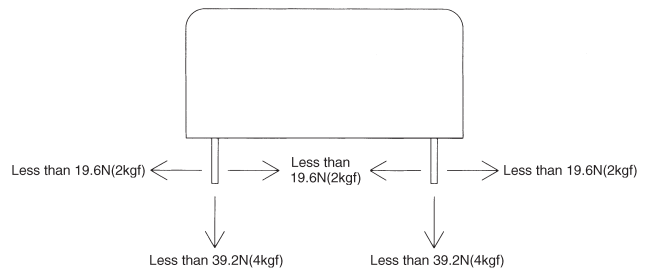
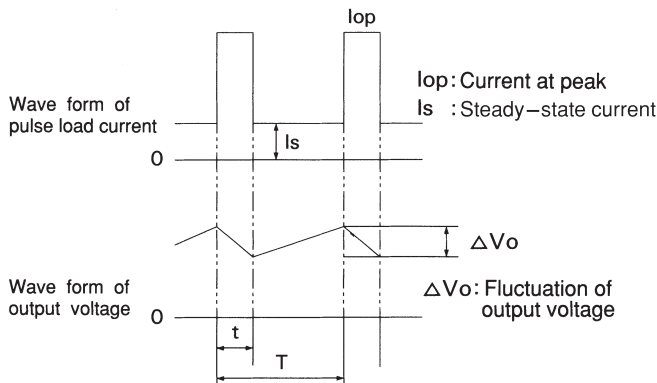
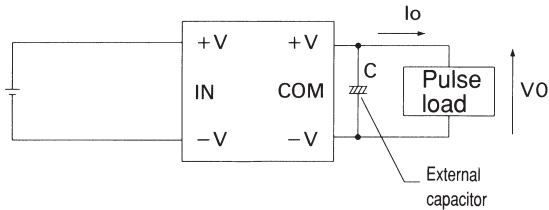

Fig.9.1 Stress onto the pins

ZU15 · ZU25

# 10 Peak Current (Pulse Load)

It is possible to supply the pulse current for the pulse load by connecting the capacitor externally at the output side.



The average current  $I_{lav}$  of output is shown in below formula.

$$I_{lav} = I_s + \frac{(I_{op} - I_s) t}{T}$$

The required electrolytic capacitor C is found by below formula.

$$C = \frac{(I_{op} - I_{lav}) t}{\Delta V_o}$$

ZT1R5 · ZT3

# 1 Pin Connection

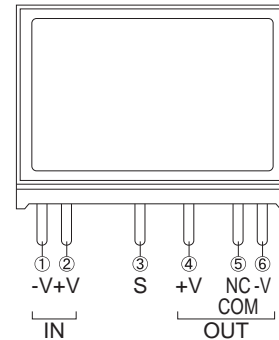

No.	Pin connection	Function
①	-DC INPUT	-Side of input voltage
②	+DC INPUT	+Side of input voltage
③	Case Connecting Pin	If connected to -side of input, the case potential can be fixed and the value of radiation noise can be reduced.
④	+DC OUTPUT	+Side of output voltage
⑤	NC (Single output) COM (Dual output)	No Connection GND of output voltage (Only applicable for Dual output)
⑥	-DC OUTPUT	-Side of output voltage

## Single Output

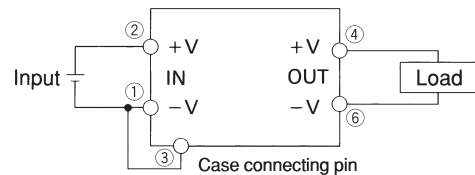

## Dual (±) Output

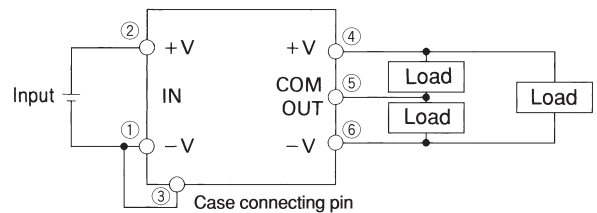

## Case Connecting Pin

Case connecting pin is available. By connecting the pin to -side of input, the radiation noise from main body can be reduced.

# 2 Function

## 2.1 Input voltage

If the wrong input is applied, the unit will not operate properly and/or may be damaged.

ZT1R5 · ZT3

2.2 Overcurrent protection

Overcurrent protection circuit is built-in and comes into effect at over 105% of the rated current.

Overcurrent protection prevents the unit from short circuit and over current condition of less than 20 sec. The unit automatically recovers when the fault condition is cleared.

The power supply which has a current foldback characteristics may not start up when connected to nonlinear load such as lamp, motor or constant current load. See the characteristics below.

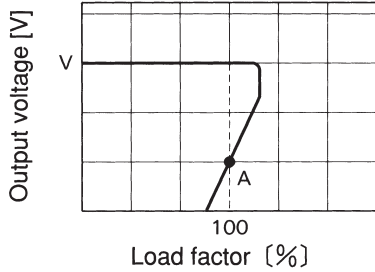

—: Load characteristics of power supply  
 - - - - -: Characteristics of load (lamp, motor, constant current load, etc.)  
 Note: In case of nonlinear load, the output is locked out at A point.

Fig.2.1 Current foldback characteristics

2.3 Isolation

For a receiving inspection, such as Hi-Pot test, gradually increase (decrease) the voltage for the start (shut down). Avoid using Hi-Pot tester with the timer because it may generate voltage a few times higher than the applied voltage, at ON/OFF of a timer.

3 Wiring to Input/ Output Pin

Input filter is built-in. A capacitor  $C_i$ , if installed near the input terminal, will lower the input conducted noise from converter due to the formation of the  $\pi$  type filter.

When the distance from the DC line to the unit is greatly extended, it makes the input feedback noise much higher and the input voltage several times higher than the normal level when turned ON. If this happens, the output power also becomes unstable. In order to prevent the unit from failing in this way; please connect  $C_i$  to the input terminal. In addition, when the filter with "L" is used, please  $C_i$  to the input terminal.

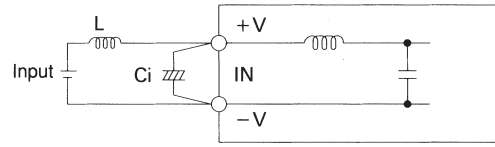

Fig.3.1 Connecting method of capacitor at input terminal

Capacity of external capacitor at input terminal:  $C_i$  [ $\mu$ F]

Model Input voltage(V)	ZTS1R5	ZTS3
	ZTW1R5	ZTW3
5	100	220
12	47	100
24	33	47
48	10	22

To lower the output ripple voltage further, install an external capacitor  $C_o$  at output terminal as shown below.

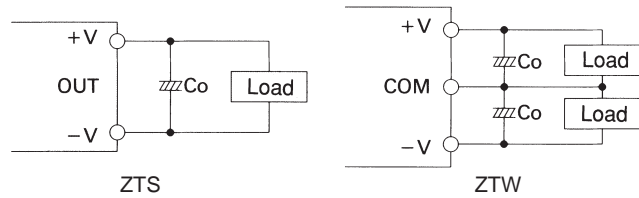

Fig.3.2 Connecting method of external capacitor at output terminal

Capacity of external capacitor at output terminal:  $C_o$  [ $\mu$ F]

Model Output voltage(V)	ZTS1R5	ZTS3
	ZTW1R5	ZTW3
5	100	220
12	100	100
15	100	100

When the distance between load and DC output is long, please install capacitor at load as shown below.

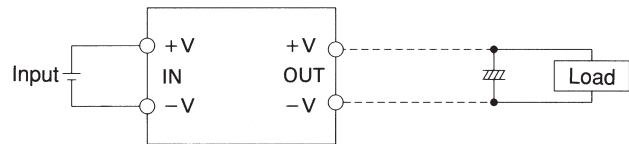

Fig.3.3 Connection method of capacitor at load

Reverse input voltage protection

Avoid the reverse polarity input voltage. It will damage the power supply.

It is possible to protect the unit from the reverse input voltage by installing an external diode as shown in Fig.3.4.

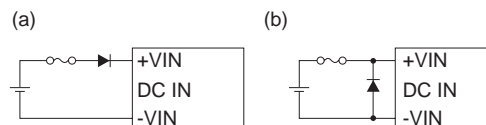

Fig.3.4 Reverse input voltage protection

ZT1R5 · ZT3

# 4 Series Operation and Parallel Operation

## 4.1 Series operation

Series operation is available by connecting the outputs of two or more power supplies, as shown below. Output currents in series connection should be lower than the lowest rated current in each unit.

But at series operation with same output voltage, diode is not required to attach even if at (a).

(a) When the output voltage is less than 5V.

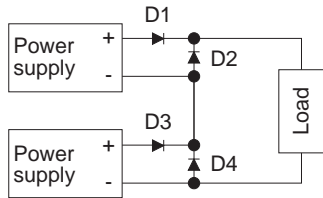

D1 - D4: Please use Schottky Barrier Diode.

(b) When the output voltage is more than 12V.

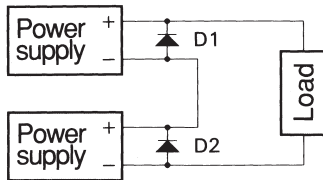

D1, D2: Please use Schottky Barrier Diode.

## 4.2 Redundancy operation

Redundancy operation is available by connecting the units as shown below.

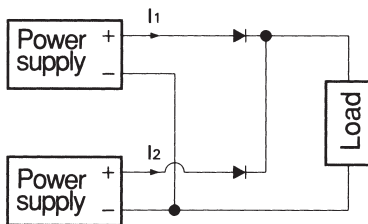

# 5 Assembling and Installation Method

## 5.1 Installation method

The unit can be mounted in any direction. Install the device, with proper intervals to allow enough air ventilation.

## 5.2 Derating

Ambient temperature around each power supply should not exceed the temperature range shown in derating curve.

It is necessary to note thermal fatigue life by power cycle.

Please reduce the temperature fluctuation range as much as possible when the up and down of temperature are frequently generated.

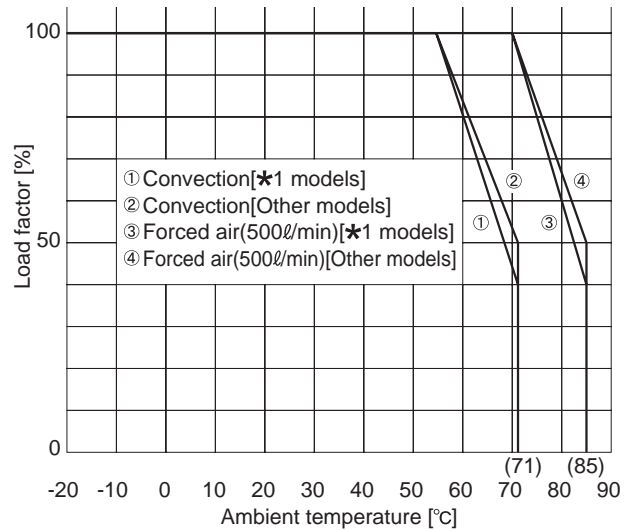

\*1 ZTS30512, ZTS30515  
ZTW30512, ZTW30515

# 6 Input Voltage/Current Range

When a non-regulated source is used as a front end, make sure that the voltage fluctuation together with the ripple voltage will not exceed the input voltage range.

Select the converter that is able to handle the start-up current ( $I_p$ ).

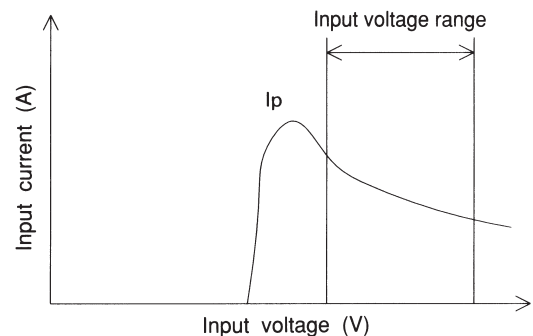

Fig.6.1 Input current characteristics

ZT1R5 · ZT3

# 7 Cleaning

■Cleaning is possible by below listed conditions.

Cleaning method

No.	Classification	Cleaning agents
1	Water type	Pine Alpha ST-100S (ARAKAWA CHEMICAL CO.)
2		Clean Through 750H (KAO Corporation)
3	Solvent type	IPA
4		Asahiklin AK-225AES (ASAHI GLASS CO.)

No.	Cleaning method	Liquid Temp.	Period
1	Varnishing or Ultra sonic wave	Less than 60°C	Within 5 minutes
2			
3	Varnishing, Ultra sonic wave, Vapor	-	Within 2 minutes
4			

■During cleaning to drying (the condition that cleaning liquid is soaked into the ink of name plate), do not touch on the surface of name plate.

■After cleaning, dry them enough.

# 8 Soldering

■Flow soldering : 260°C less than 15 seconds.

■Soldering iron : 450°C less than 5 seconds.

# 9 Input/Output Pin

■When too much stress is applied on the input/output pins of the unit, the internal connection may be weakened. As below Fig.9.1, avoid applying stress of more than 9.8N (1kgf) horizontally and more than 19.6N (2kgf) vertically.

■When additional stress is expected to be put on the input/output pins because of vibration or impacts, fix the unit on PCB (using silicone rubber or fixing fittings) to reduce the stress onto the input/output pins.

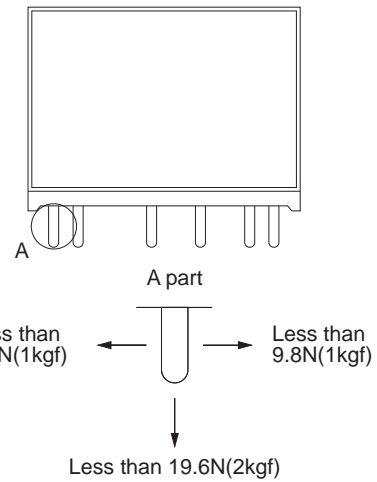
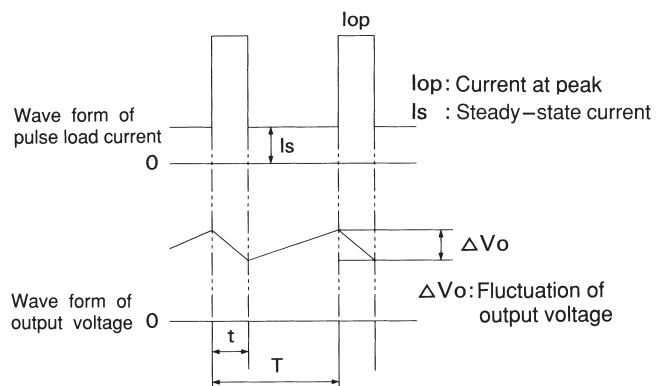
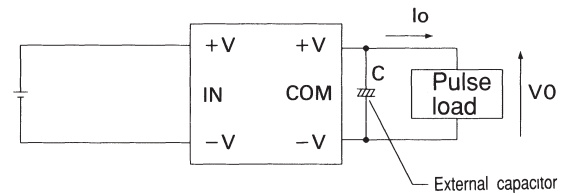

Fig.9.1 Stress onto the pins

# 10 Peak Current (Pulse Load)

■It is possible to supply the pulse current for the pulse load by connecting the capacitor externally at the output side.



■The average current Iav of output is shown in below formula.

$$I_{av} = I_s + \frac{(I_{op} - I_s) t}{T}$$

■The required electrolytic capacitor C is found by below formula.

$$C = \frac{(I_{op} - I_{av}) t}{\Delta V_o}$$