

Basic Characteristics Data

Model	Circuit method	Switching frequency [kHz]	Input current [A]	Rated input fuse	Inrush current protection	PCB/Pattern			Series/Parallel operation availability	
						Material	Single sided	Double sided	Series operation	Parallel operation
PAA50F	Forward converter one converter*2	90 - 250	0.8	250V 2A	Combination of inverter	CEM-3	Yes		Yes	*1
PAA75F	Forward converter one converter*2	90 - 250	1.2	250V 3A	Combination of inverter	CEM-3	Yes		Yes	*1
PAA100F	Active filter	90	1.4	250V 3A	Thermistor	CEM-3	Yes		Yes	*1
	Forward converter	140								
PAA150F	Active filter	90	2.0	250V 5A	Thermistor	CEM-3	Yes		Yes	*1
	Forward converter	140								
PAA300F	Active filter	110	4.4	250V 10A	SCR	FR-4		Yes	Yes	Yes
	Forward converter	220								
PAA600F	Active filter	110	8.2	250V 20A	SCR	FR-4		Yes	Yes	Yes
	Forward converter	220								

*1 Refer to Instruction Manual.

*2 The switching frequency of forward converter/one converter changes according to input voltage and load factor.

* The value of input current is at ACIN 100V and rated load.

1 Terminal Block PAA-16**2** Function PAA-17

2.1	Input voltage range	PAA-17
2.2	Inrush current limiting	PAA-17
2.3	Overcurrent protection	PAA-17
2.4	Overvoltage protection	PAA-17
2.5	Output voltage adjustment range	PAA-17
2.6	Remote ON/OFF	PAA-17
2.7	Remote sensing	PAA-18
2.8	Isolation	PAA-19
2.9	Thermal protection	PAA-19

3 Series Operation and Parallel Operation PAA-19

3.1	Series operation	PAA-19
3.2	Parallel operation/Master-slave operation	PAA-19

4 Assembling and Installation Method PAA-20

4.1	Installation method	PAA-20
4.2	Derating	PAA-20
4.3	Mounting screw	PAA-22

1 Terminal Block

●PAA50F

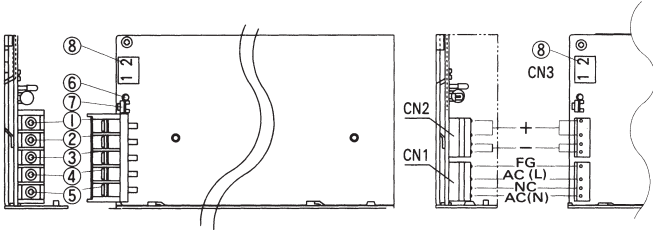

- ①+Output
- ②-Output
- ③Frame ground
- ④AC(L)
- ⑤AC(N)
- ⑥LED
- ⑦Output voltage adjustable potentiometer
- ⑧Connector for Remote ON/OFF(Optional)
1: RC(+)
2: RC(-)

●PAA75F

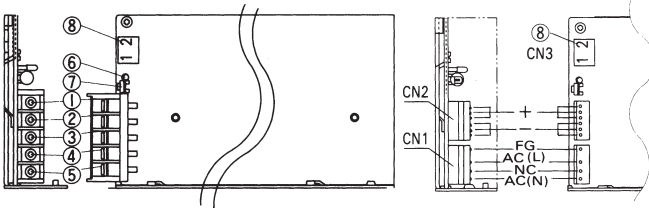

- ①+Output
- ②-Output
- ③Frame ground
- ④AC(L)
- ⑤AC(N)
- ⑥LED
- ⑦Output voltage adjustable potentiometer
- ⑧Connector for Remote ON/OFF(Optional)
1: RC(+)
2: RC(-)

●PAA100F

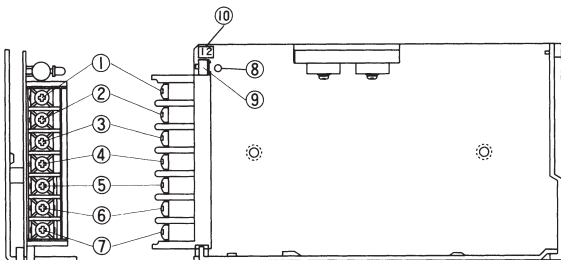

- ①+Remote sensing(+S)
- ②+Output
- ③-Output
- ④-Remote sensing(-S)
- ⑤Frame ground
- ⑥AC(L)
- ⑦AC(N)
- ⑧LED
- ⑨Output voltage adjustable potentiometer
- ⑩Connector for Remote ON/OFF(Optional)
1: RC(+)
2: RC(-)

●PAA150F

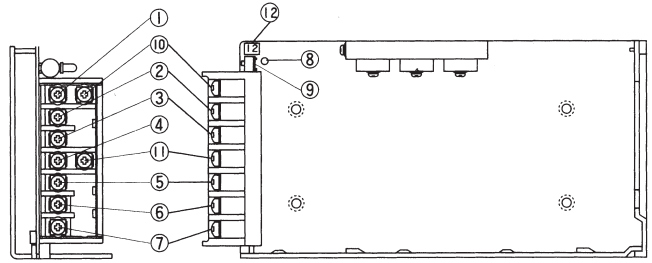

- ①②+Output
- ③④-Output
- ⑤Frame ground
- ⑥AC(L)
- ⑦AC(N)
- ⑧LED
- ⑨Output voltage adjustable potentiometer
- ⑩+Remote sensing(+S)
- ⑪-Remote sensing(-S)
- ⑫Connector for Remote ON/OFF(Optional)
1: RC(+)
2: RC(-)

●PAA300F

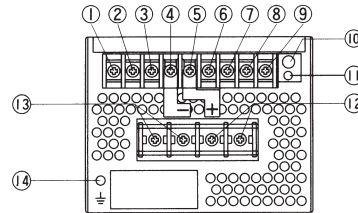

- ①AC(L)
- ②AC(N)
- ③Frame ground
- ④-Remote sensing(-S)
- ⑤+Remote sensing(+S)
- ⑥Current balance(CB)
- ⑦Voltage balance(VB)
- ⑧Remote ON/OFF(RG)
- ⑨Remote ON/OFF(RC)
- ⑩Output voltage adjustable potentiometer
- ⑪LED
- ⑫+Output
- ⑬-Output
- ⑭Frame ground

●PAA600F

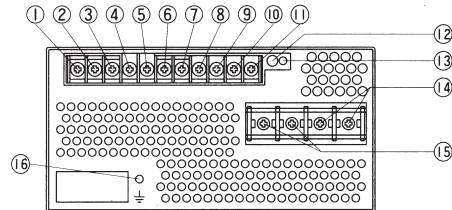

- ①AC(L)
- ②AC(N)
- ③Frame ground
- ④Remote ON/OFF(RG)
- ⑤Remote ON/OFF(RC)
- ⑥Current balance(CB)
- ⑦Voltage balance(VB)
- ⑧-Remote sensing(-S)
- ⑨-Output voltage monitoring(-M)
- ⑩+Output voltage monitoring(+M)
- ⑪+Remote sensing(+S)
- ⑫Output voltage adjustable potentiometer
- ⑬LED
- ⑭+Output
- ⑮-Output
- ⑯Frame ground

2 Function

2.1 Input voltage range

- The range is from AC85V to AC264V.
- AC input voltage must have a range from AC85V to AC264V for normal operation. If the wrong input is applied, the unit will not operate properly and/or may be damaged.
- In cases that conform with safety standard, input voltage range is AC100-AC240V(50/60Hz).

2.2 Inrush current limiting

- Inrush current limiting is built-in.
- If a switch on the input side is installed, it has to be the one handling the input inrush current.

● PAA100F · PAA150F

- The thermistor is used for protection from inrush current. When power is turned ON/OFF repeatedly within a short period of time, it is necessary to have enough time for power supply to cool down.

● PAA300F · PAA600F

- The thyristor technique is used for protection from inrush current. When power is turned ON/OFF repeatedly within a short period of time, it is necessary to have enough time between power ON and OFF to operate resistance circuit for inrush current.

2.3 Overcurrent protection

- Overcurrent protection is built-in and comes into effect at over 105% of the rated current. Overcurrent protection prevents the unit from short circuit and overcurrent condition of less than 20 sec. The unit automatically recovers when the fault condition is cleared.

● PAA300F · PAA600F

- If the output voltage drops more than 50% of the rated voltage in an overcurrent protection mode, the average current will also be reduced by the intermittent operation.

2.4 Overvoltage protection

- The overvoltage protection circuit is built-in and comes into effect at 115 - 140% of the rated voltage(except 3V output voltage type: it operates at 4.0 - 5.25V). The AC input should be shut down if overvoltage protection is in operation. The minimum interval of AC recycling for recovery is 1 1/2 minutes to 3 1/2 minutes.

★ The recovery time varies depending on input voltage.

Remarks:

Please avoid applying the over-rated voltage to the output terminal. Power supply may operate incorrectly or fail. In case of operating a motor etc., please install an external diode on the output terminal to protect the unit.

2.5 Output voltage adjustment range

- Adjustment of output voltage is possible by using potentiometer.
- Output voltage is increased by turning potentiometer clockwise and is decreased by turning potentiometer counterclockwise.

2.6 Remote ON/OFF

● PAA300F · PAA600F

- Remote ON/OFF circuit (RC, RG) is isolated from input, output and FG.

Between RC and RG: Output voltage is ON at "Low" level or short circuit (0 - 0.8V).

Between RC and RG: Output voltage is OFF at "High" level or open circuit (2.7 - 5.0V).

Connection example:

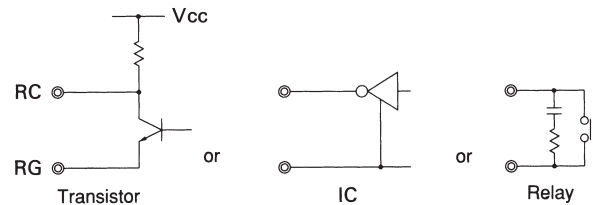

When RC terminal is "Low" level, fan out current is 3mA typ. When Vcc is applied, use $5V \leq V_{cc} \leq 12V$. When remote ON/OFF function is not used, please short between RC and RG terminals.

● PAA50F · PAA75F · PAA100F · PAA150F (Optional "-R")

- Option "-R" is available for remote ON/OFF.

Between RC(+) and RC(-)	Output
SW ON (4.5 - 12.5V)	ON
SW OFF (0 - 0.5V)	OFF

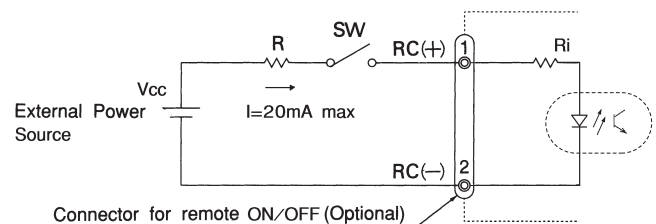

- When external power source is in the range of 4.5 - 12.5V, current limit resistance R is not required. However, when external power source exceeds 12.5V, current limit resistance R must be connected.

To calculate the current limit resistance use following equation:

$$R [\Omega] = \frac{V_{cc} - (1.1 + R_i \cdot 0.005)}{0.005}$$

where;

V_{cc} = External Power Source

R_i = The internal resistance(see table)

Model	R _i [Ω]
PAA50F/75F	660
PAA100F/150F	780

- A wrong connection may damage the internal components of the unit.
- Remote ON/OFF circuit (RC(+), RC(-)) is isolated from input, output and FG.

2.7 Remote sensing

- When not using this function, confirm that terminals are shorted between +S and +V, and between -S and -V with short pieces. For PAA600F model, connect between +S and +M, and between -S and -M.
- When using this function, wiring should be done without short pieces.
- Device inside power supply might be damaged when poor connection on load lines occurs, e.g. because of loose connector screws.
- Thick wire should be used for wiring between power supply and load, and line voltage drop should be less than 0.3V.
- When long sensing wire is required, use C1, C2 and C3.
- Twisted-pair wire or shield wire should be used for sensing wire.
- Maximum current per a terminal is as follows:
When current exceeds more than the following list, two terminals are required.

Model	Terminal rated current
PAA100F	20A
PAA150F	20A
PAA300F	60A
PAA600F	60A

- When remote sensing function is used, output voltage might become unstable because of a impedance of wiring and load condition. And the power supply should be evaluated enough. Following are examples to improve it.

- * -S sensing wire is removed and terminals between -M and -S are shorted.
- * C1, C2, C3 and R1 are connected as above figure.

●PAA100F

(1)When not using remote sensing function

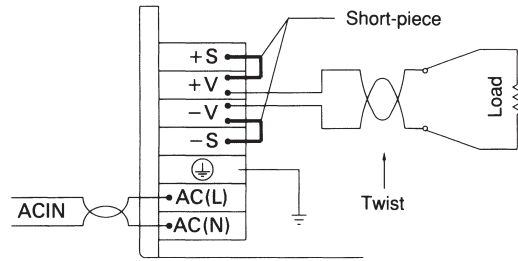

(2)When using remote sensing function

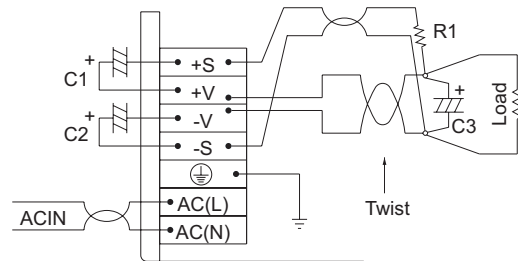

●PAA150F

(1)When not using remote sensing function

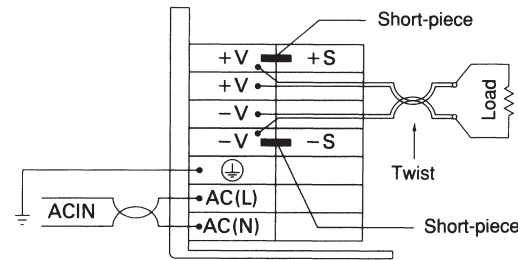

(2)When using remote sensing function

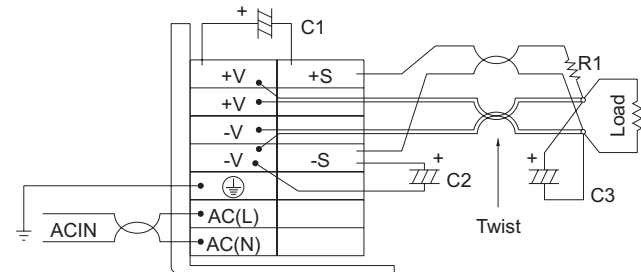

●PAA300F

(1)When not using remote sensing function

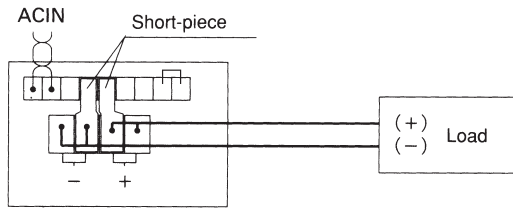

(2)When using remote sensing function

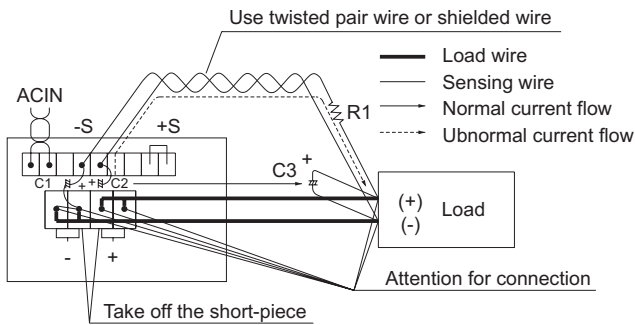

●PAA600F

(1)When not using remote sensing function

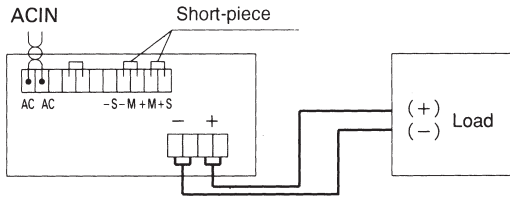

(2)When using remote sensing function

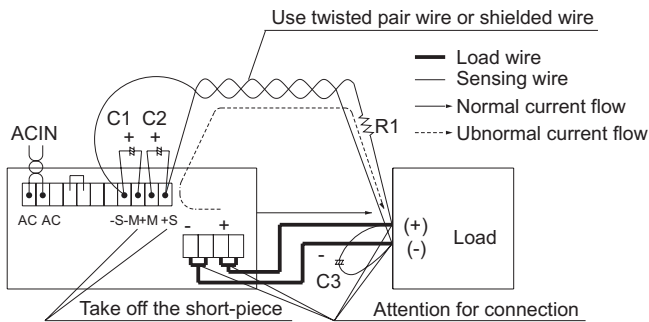

2.8 Isolation

■For a receiving inspection, such as Hi-Pot test, gradually increase(decrease)the voltage for start(shut down). Avoid using Hi-Pot tester with the timer because it may generate voltage a few times higher than the applied voltage, at ON/OFF of a timer.

If the unit is tested on the isolation between input & output and output & FG, remote ON/OFF must be shorted to output.

2.9 Thermal protection

●PAA300F · PAA600F

■Thermal protection is built-in. If this function comes into effect, shut down the output, eliminate all possible causes of overheating, and drop the temperature to normal level. Output voltage recovers after applying input voltage. To prevent the unit from overheating, avoid using the unit in a dusty, poorly ventilated environment.

3 Series Operation and Parallel Operation

3.1 Series operation

■Series operation is available by connecting the outputs of two or more power supplies, as shown below. Output current in series connection should be lower than the lowest rated current in each unit.

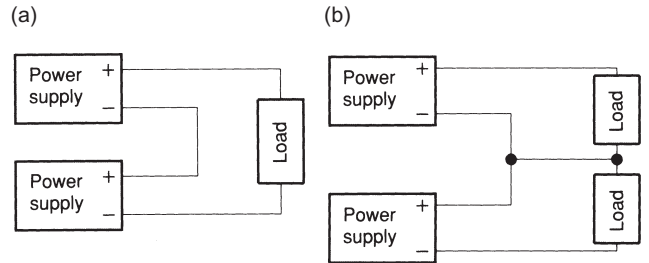

3.2 Parallel operation/master-slave operation

●PAA50F · PAA75F · PAA100F · PAA150F

■Parallel operation is not possible.
■Redundancy operation is available by wiring as shown below.

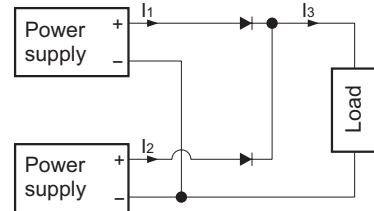

■Even a slight difference in output voltage can affect the balance between the values of I1 and I2.

Please make sure that the value of I3 does not exceed the rated current of a power supply.

$$I_3 \leq \text{the rated current value}$$

●PAA300F · PAA600F

- Parallel redundancy operation is available by connecting the units as shown below.
- As variance of output current drew from each power supply is maximum 10%, the total output current must not exceed the value determined by the following equation.

(Output current at parallel operation)
 = (the rated current per unit) × (number of unit) × 0.9

When the number of units in parallel operation increases, input current increases at the same time.
 Adequate wiring design for input circuitry is required, such as circuit pattern, wiring and current capacity for equipment.

In parallel operation, the maximum operative number of units is 5.

- Output voltage in parallel operation is adjustable by using the potentiometer of the "master" unit.
 Select one power supply to be the master, and turn the potentiometer of the other, "slave" power supplies, clockwise to the end. Then use the potentiometer of the mater to adjust output voltage.
- When remote sensing is used in parallel operation, the sensing wire must be connected ONLY to master.

●PAA300F

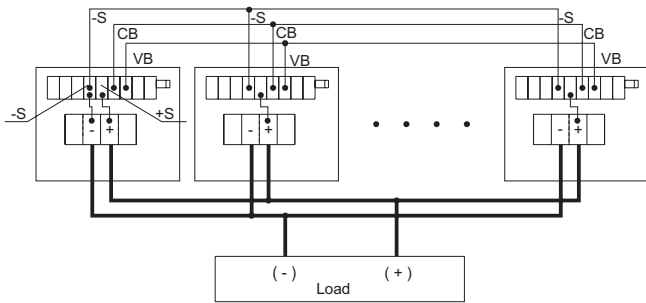

●PAA600F

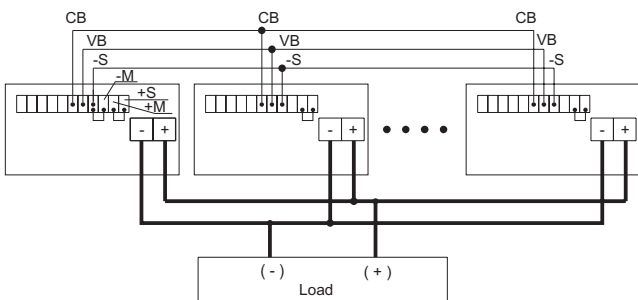

- In parallel operation, output voltage increases like stairs due to a delay of the rise time of output voltage at turn on.

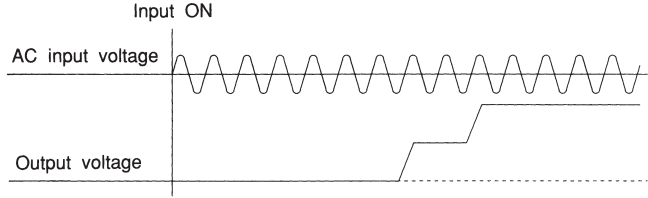

4 Assembling and Installation Method

4.1 Installation method

●PAA50F · PAA75F · PAA100F · PAA150F

- When two or more power supplies are used side by side, position them with proper intervals to allow enough air ventilation. Ambient temperature around each power supply should not exceed the temperature range shown in derating curve.

●PAA300F · PAA600F

- Fan for forced cooling is built-in. Do not block the ventilation at suction side (terminal block side) and its opposite side.
- When unit operates at dusty place, attach air-filter to dust into the unit. In this case, avoid poorly ventilated environments .
- When internal fan stops, thermal protection circuit works which stops the output. To keep reliability of the unit, periodic maintenance of the fan is required.
- The expected life time of fan is different by operating condition.

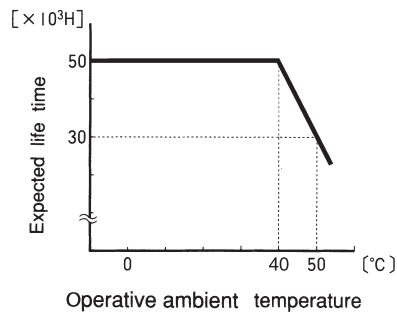

4.2 Derating

- The operative ambient temperature is different by with/without case cover or mounting position. Please refer drawings as below.
- When unit mounted except below drawings, it is required to consider ventilated environment by forced air cooling or temperature/load derating. For details, please consult our sales or engineering departments.

●PAA50F

(1)Mounting method

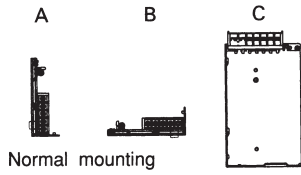

(2)Derating curve

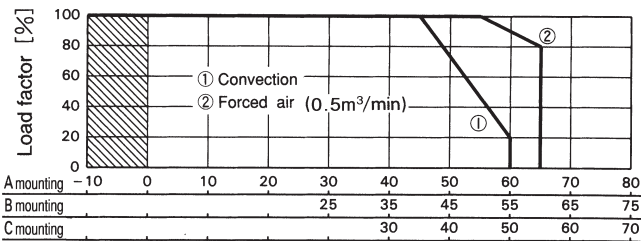
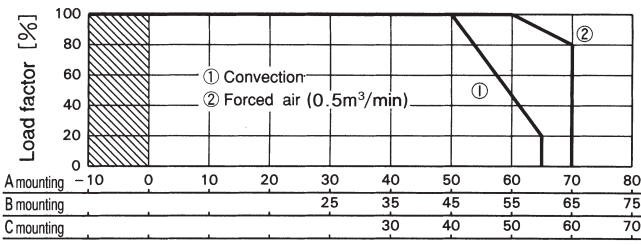

Note: In the hatched area, the specification of Ripple, Ripple Noise is different from other area.

●PAA75F

(1)Mounting method

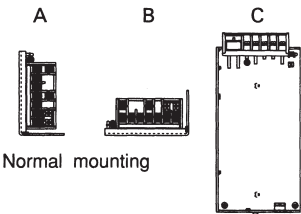

(2)Derating curve

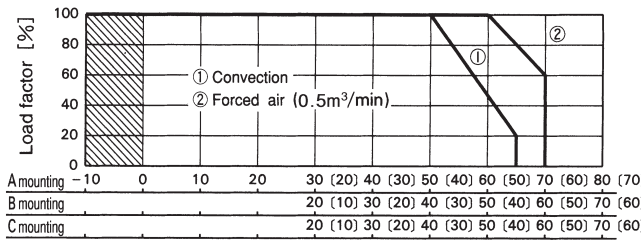

■Specifications inside the hatched area, Ripple · Ripple Noise is changed.

●PAA100F

(1)Mounting method

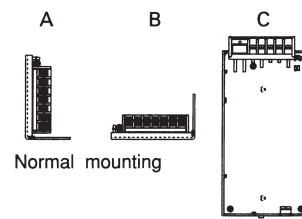

(2)Derating curve

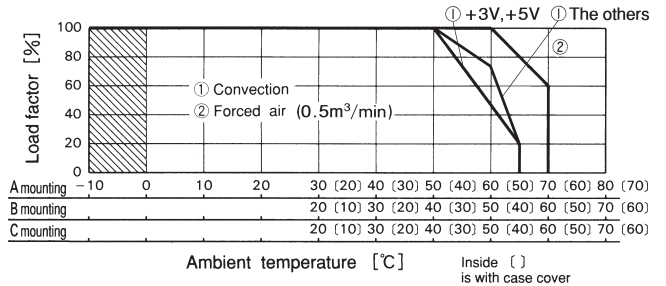

■Specifications inside the hatched area, Ripple · Ripple Noise is changed.

●PAA150F

(1)Mounting method

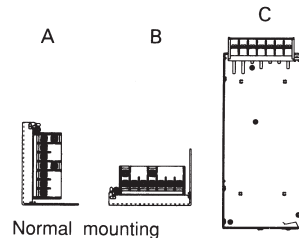

(2)Derating curve

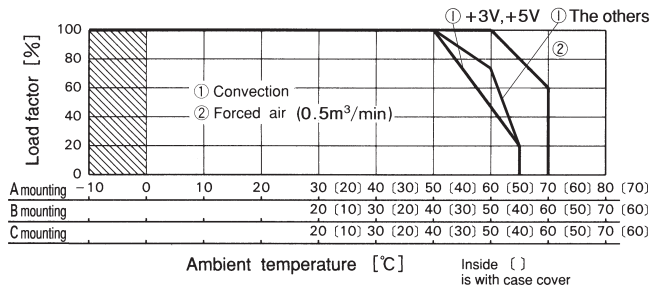

■Specifications inside the hatched area, Ripple · Ripple Noise is changed.

●PAA300F

Derating curve

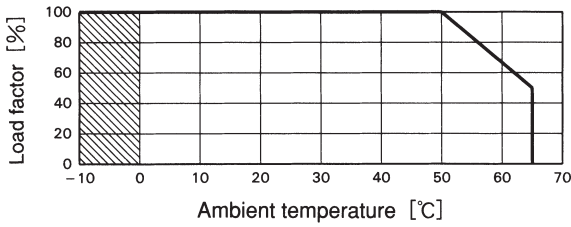

■Specifications inside the hatched area, Ripple · Ripple Noise is changed.

●PAA600F

Derating curve

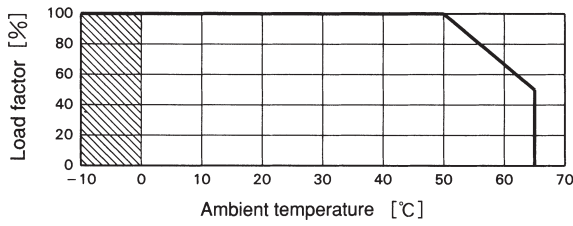

■Specifications inside the hatched area, Ripple · Ripple Noise is changed.

4.3 Mounting screw

■Keep isolation distance between screw and internal components, as below chart.

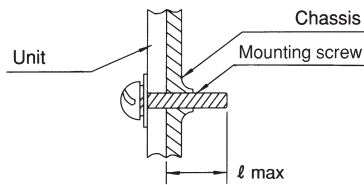

Unit : [mm]

Model	l max	Model	l max
PAA50F	6	PAA150F	8
PAA75F	6	PAA300F	8
PAA100F	8	PAA600F	8