

1	Function	AEA-8
	1.1 Input voltage range	AEA-8
	1.2 Inrush Current Limiting	AEA-8
	1.3 Overcurrent protection	AEA-8
	1.4 Peakcurrent protection	AEA-8
	1.5 Overvoltage protection	AEA-8
	1.6 Output voltage adjustment range	AEA-8
	1.7 Thermal protection	AEA-8
	1.8 Output ripple and ripple noise	AEA-8
	1.9 Isolation	AEA-9
2	Series Operation and Parallel Operation	AEA-9
	2.1 Series Operation	AEA-9
	2.2 Parallel operation/master-slave operation	AEA-9
	2.3 N+1 Parallel Redundancy Operation	AEA-9
3	Life expectancy and Warranty	AEA-10
4	Peak current	AEA-10
5	Ground	AEA-11
6	Options	AEA-11
	6.1 Outline of Options	AEA-11
	6.2 Medical Isolation Grade	AEA-13

1 Function

1.1 Input voltage range

- The range is from 85VAC to 264VAC.
In cases that conform with safety standard, input voltage range is 100VAC to 240VAC (50/60Hz).
- If input value doesn't fall within above range, a unit may not operate in accordance with specifications and/or start hunting or fail.
If you need to apply a square waveform input voltage, which is commonly used in UPS and inverters, please contact us.
- When the input voltage changes suddenly, the output voltage accuracy might exceed the specification. Please contact us.
If the restart time of the short interruption power failure is less than 3 seconds, perform a thorough evaluation.
- A unit can operate under the input voltage dip with derating.
Table1.1 and 1.2 shows the load factors that can be output.

Table1.1 IEC60601-1-2 Maximum output load factor

Voltage Dip		duration [ms]	AEA600F
100VAC	→ 0VAC	20	100%
100VAC	→ 40VAC	100	100%
100VAC	→ 70VAC	500	100%
240VAC	→ 0VAC	20	100%
240VAC	→ 96VAC	100	100%
240VAC	→ 168VAC	500	100%

Table1.2 SEMI F47-0706 Maximum output load factor

Voltage Dip		duration [ms]	AEA600F
100VAC	→ 50VAC	200	100%
100VAC	→ 70VAC	500	100%
100VAC	→ 80VAC	1000	100%
200VAC	→ 100VAC	200	100%
200VAC	→ 140VAC	500	100%
200VAC	→ 160VAC	1000	100%

* 100% Load factor in table 1.1 and 1.2 means the rated current (forced air cooling) in Specifications.

1.2 Inrush Current Limiting

- An inrush current limiting circuit is built-in.
- If you need to use a switch on the input side, please select one that can withstand an input inrush current.
- Relay technique is used in the inrush current limiting circuit. When you turn the power ON/OFF repeatedly within a short period of time, please have enough intervals so that the inrush current limiting circuit becomes operative.
- When the switch of the input is turned on, the primary inrush current and secondary inrush current will be generated because the relay technique is used for the inrush current limiting circuit.

1.3 Overcurrent protection

- Overcurrent protection is built-in and comes into effect over 101% of the peak current in. Overcurrent protection prevents the unit from short circuit and overcurrent condition.
The unit automatically recovers when the fault condition is cleared.

- When the overcurrent protection continues, the output will be shut down.
- Output voltage recovers from overcurrent protection by shutting down the input voltage and waiting more than 3 minutes then turning on AC input again.

1.4 Peakcurrent protection

- Peakcurrent protection is built-in (The protection circuit operates when load current exceeds the rating current and the use deviates from the condition in Instruction Manual 4).
The output will be recovered automatically after removing causes of the fault.

1.5 Overvoltage protection

- An overvoltage protection circuit is built-in. If the overvoltage protection circuit is activated, shut down the input voltage, wait more than 3 minutes and turn on the AC input again to recover the output voltage. Recovery time varies depending on such factors as input voltage value at the time of the operation.

Remarks :

Please avoid applying a voltage exceeding the rated voltage to an output terminal. Doing so may cause a power supply to malfunction or fail. If you cannot avoid doing so, for example, if you need to operate a motor, etc., please install an external diode on the output terminal to protect the unit.

1.6 Output voltage adjustment range

- To increase an output voltage, turn a built-in potentiometer clockwise. To decrease the output voltage, turn it counterclockwise.

1.7 Thermal protection

- Thermal protection circuit is built-in and shut down under following condition.
 - ①When the current and the temperature which exceed from the derating curve.
 - ②The case FAN stops or air flow is interrupted and the amount of the wind decreases.
 If the thermal protection activates, shut off input voltage, remove the cause of the overheating, wait for the unit to cool down, and recycle to recover output voltage.

1.8 Output ripple and ripple noise

- Output ripple noise may be influenced by measurement environment, measuring method Fig.1.1 is recommended.

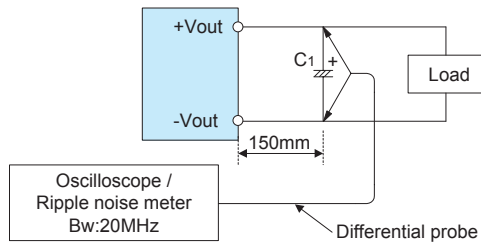

C1 : Aluminum electrolytic capacitor 22μF

Fig.1.1 Measuring method of Ripple and Ripple Noise

Remarks :

When GND cable of probe with flux of magnetic force from power supply are crossing, ripple and ripple noise might not measure correctly.

Please note the measuring environment.

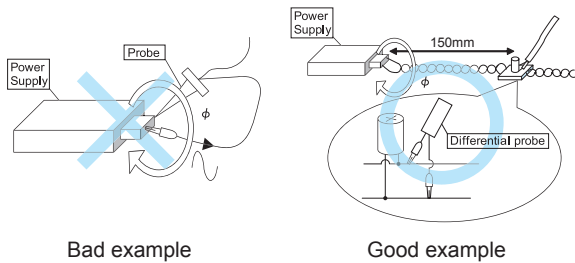

Fig.1.2. Example of measuring output ripple and ripple noise

1.9 Isolation

For a receiving inspection, such as Hi-Pot test, gradually increase (decrease) the voltage for the start (shut down). Avoid using Hi-Pot tester with the timer because it may generate voltage a few times higher than the applied voltage, at ON/OFF of a timer.

2 Series Operation and Parallel Operation

2.1 Series Operation

You can use a power supply in series operation. The output current in series operation should be lower than the rated current of a power supply with the lowest rated current among power supplies that are serially connected. Please make sure that no current exceeding the rated current flows into a power supply.

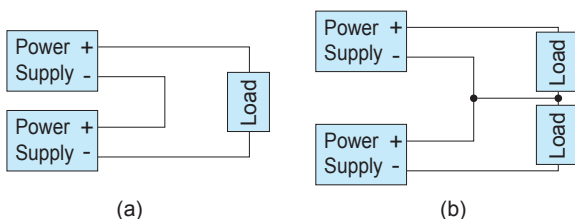

Fig.2.1 Examples of connecting in series operation

In series operation, the maximum operative number of units is 9. The combined output voltage of series operation is 200V.

2.2 Parallel operation/master-slave operation

As variance of output current drawn from each power supply is maximum 10%, the total output current must not exceed the value determined by the following equation.

$$\left[\text{Output current in parallel operation} \right] = \left[\text{The rated current per unit} \right] \times (\text{Number of unit}) \times 0.9$$

When the number of units in parallel operation increases, input current increases at the same time. Adequate wiring design for input circuitry is required, such as circuit pattern, wiring and current capacity for equipment.

In parallel operation, the maximum operative number of units is 6.

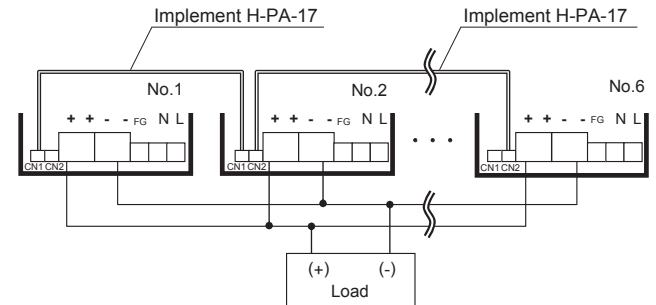

Fig.2.2 Connection method in parallel

Output voltage in parallel operation is adjustable by using the potentiometer of the "master" unit. Select one power supply to be the master, and turn the potentiometer of the other, "slave" power supplies, clockwise to the end. Then use the potentiometer of the master to adjust output voltage.

In series operation or parallel operation, output voltage increases like stairs due to a delay of the rise time of output voltage at turn on.

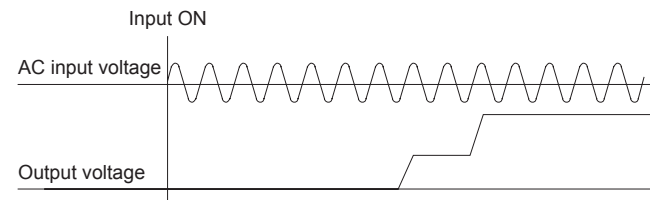

Fig.2.3 Start-up wave form in series and/or parallel operation

2.3 N+1 Parallel Redundancy Operation

You can have N+1 redundancy operation for improving system reliability.

If you add one extra power supply in parallel operation, even if one of the power supplies in your system fails, the remaining non-failed power supplies continue to sustain the system. If one of the power supplies stops operating, the output voltage may change about 5%.

When unit replacement is required due to unit failure, input voltage for all units must be cut off.

- After replacement, please make sure that all wirings are completed correctly, before re-applying input voltage.
- Hot-swap or Hot-plug is not available.
- If 2 or more units failed, sufficient power could not be provided to the system. Therefore, please replace the failed unit immediately in case where unit failure is found.
- If you have any questions about series, parallel and N+1 redundancy operations, please contact us.

3 Life expectancy and Warranty

- Life expectancy
Life expectancy is as follows.

Table3.1 Life expectancy

Mount	Average ambient temperature (yearly)	Life expectancy	
		$l_o \leq 50\%$	$50 < l_o \leq 100\%$
All mounting direction	$T_a \leq 30^\circ\text{C}$	10 years or more	10 years or more
	$T_a = 40^\circ\text{C}$	10 years or more	6 years
	$T_a = 50^\circ\text{C}$	5 years	3 years
Forced air	$T_a \leq 30^\circ\text{C}$	10 years or more	10 years or more
	$T_a = 40^\circ\text{C}$	10 years or more	6 years
	$T_a = 50^\circ\text{C}$	5 years	3 years

- Warranty
The warranty is 5 years when average ambient temperature of year is $T_a = 50^\circ\text{C}$ or less and load factor is average 50% or less. However, the warranty is 3 years when average ambient temperature of year is $T_a = 50^\circ\text{C}$ or less and load factor is series 100%.

4 Peak current

- Peak current can be used at the below condition.

- $t_1 \leq 5\text{sec}$
- $I_p \leq \text{Rated peak current}$
- $I_{rms} \leq \text{Rated current}$
- $I_{rms}^2 = \frac{I_p^2 \times t_1 + I_L^2 \times t_2}{t_1 + t_2}$

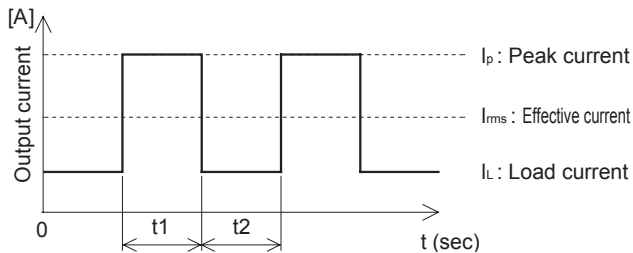

Fig.4.1 Peak current

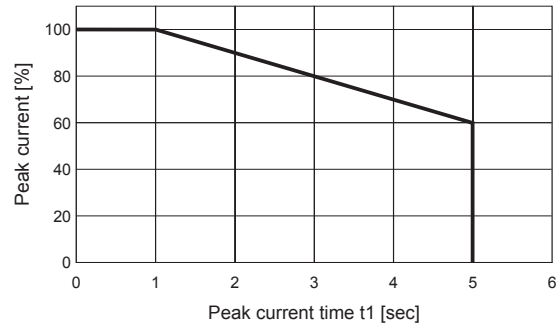

Fig.4.2 Relation between Peak current time and Peak current

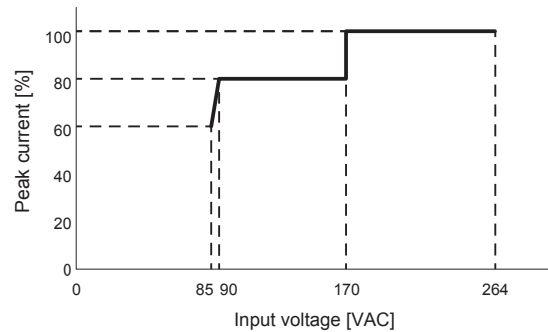

Fig.4.3 Derating curve depends on Input voltage

- Ex. Peak current calculation

Model : AEA600F-24

Conditions :

V_{in} : 100VAC Cooling method : convection cooling T_a : 40°C

I_p = 30A, t_1 = 3sec

I_L = 10A, t_2 = 40sec

- ① Calculate I_{rms}

$$I_{rms}^2 = \frac{I_p^2 \times t_1 + I_L^2 \times t_2}{t_1 + t_2} = \frac{30^2 \times 4 + 10^2 \times 40}{3 + 40} = 155.81$$

$$I_{rms} = \sqrt{155.81} = 12.48$$

- ② Allowed I_p max

Input voltage derating @100VAC = 80%

Peak current time derating @ t_1 : 3sec = 80%

I_p max = 52.5 (Rated peak current) \times 80% \times 80% = 33.6A

- ③ Allowed I_{rms} max

Input voltage derating @100VAC = 80%

Ambient temperature derating T_a : 40°C = 100%

I_{rms} max = 17.5 (Rated current convection cooling) \times 80% \times 100% = 14A

- ④ Judgment

I_p and I_{rms} do not exceed the maximum condition. Pass

5 Ground

- When installing the power supply with your unit, ensure that the mounting hole FG is connected to safety ground of the unit.
- * It is recommended to electrically connect terminal FG and mounting hole FG to metal chassis for reducing noise.

6 Options

6.1 Outline of Options

● -C

- Except a certain (e.g.terminal, potentiometer), PCB is coated.

● -N

- Option -N models come with a cover.
- Appearance of Option -N models are different from that of standard models. Please see External View for details.
- Derating curve for Option -N models is different from that for standard models. Please see "Derating" for details.

● -T

- Option -T models have vertically positioned screws on a terminal block.
- Please contact us for details about appearance.

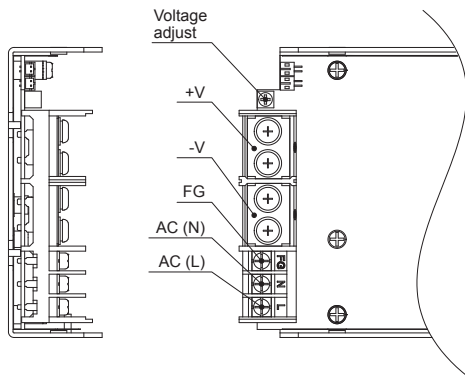

Fig 6.1 Example of option -T (AEA600F)

● -J

- -J means terminal block is changed to connector. (Mfr : TE Connectivity).
- Please contact us for details about appearance.

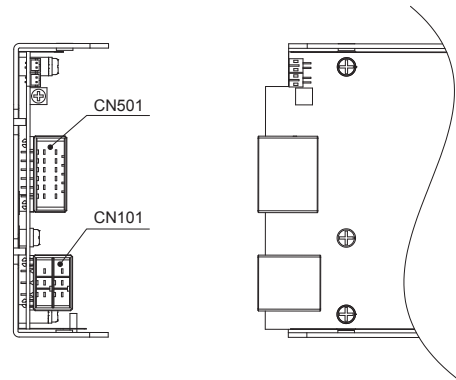

Fig 6.2 Example of option -J (AEA600F)

Table 6.1 Pin assignments of CN101

	Pin No.	Input
A	1	N
	2	NC
	3	L
B	1	N
	2	NC
	3	L

Table 6.2 Pin assignments of CN501

	PinNo.	Output
A	1	+V
	2	+V
	3	+V
	4	-V
	5	-V
	6	-V
B	1	+V
	2	+V
	3	+V
	4	-V
	5	-V
	6	-V

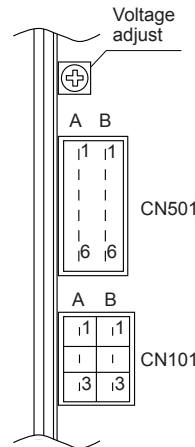

Table 6.3 Mating connectors and terminals on CN101 and CN501

Connector	Housing	Terminal	Mfr
CN101	1-178139-5	1-178129-6	1-175218-5 equivalent goods
CN501	178306-5	178289-6	1-353717-5 equivalent goods

TE Connectivity

*Keep drawing current per pin below 8.5A

● -R3

- The following features are included.
- Please refer to the optional parts for the dedicated harness.
- Please contact us for details about appearance.

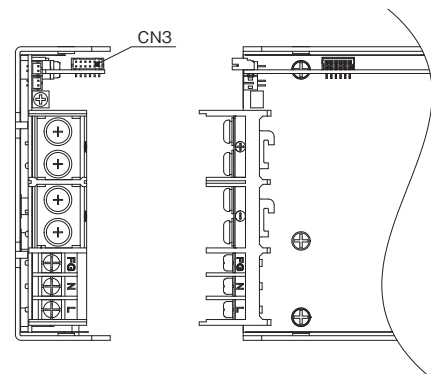

Fig 6.3 Example of option -R3 (AEA600F)

Table 6.4 Pin assignments of CN3

Pin No.	Function
1	AUX1+ : AUX1 (12V1A)
2	AUX1- : AUX1 (GND)
3	AUX2+ : AUX2 (5V1A)
4	AUX2- : AUX2 (GND)
5	AUX2+ : AUX2 (5V1A)
6	AUX2- : AUX2 (GND)
7	RC+ : Remote ON/OFF
8	RC- : Remote ON/OFF (GND)
9	PG+ : PG Alarm
10	PG- : PG Alarm (GND)
11	PR+ : PR Alarm
12	PR- : PR Alarm (GND)

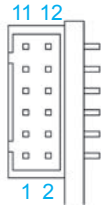

Table 6.5 Mating connectors and terminals on CN3

Connector	Housing	Terminal	Mfr
CN3	S12B-PHDSS	PHDR-12VS	Reel : SPHD-002T-P0.5 Loose : BPHD-001T-P0.5 *1 BPHD-002T-P0.5 *1
			J.S.T.

*1 The manufacturer can offer only ratchet hand tool

- AUX1 12V0.5A (convection cooling), 12V1A (forced air)
 - This power supply is equipped with an auxiliary 12V output AUX1 (12V±10%) which is available from CN3.
 - AUX1 is not isolated from the main output circuit.
 - Do not exceed the current rating, it may causes malfunction or failure of the internal circuitry.

- AUX2 5V0.5A (convection cooling), 5V1A (forced air)
 - Output AUX2 is provided from CN3. AUX2 (5V±5%) can be used to power up remote control or other circuits.
 - AUX2 has been isolated from other circuit (input, output, FG, RC).
 - Do not exceed the current rating, it may causes malfunction or failure of the internal circuitry.

- Remote ON/OFF
 - You can operate the remote ON/OFF function by sending signals to CN601. Please see Table 6.6 for specifications and Fig.6.4 for connecting examples.
 - Remote ON/OFF circuits (RC and RCG) are isolated from input, output FG and AUX.
 - Please note the following when using the remote ON/OFF function.

- ①Turns on by drawing current to RC.
- ②The current flow to RC is a 5mA typ (maximum 25mA).
- ③If the output voltage is turned off through the remote ON/OFF circuit, 12V AUX stops.
- ④If current of a value not listed in Table 6.6 is applied between RC+ and RC-, the output voltage may not be generated normally.
- ⑤Please wire carefully. If you wire wrongly, the internal components of a unit may be damaged.

* If the output of an external power supply is within the range of 4.5 - 12.5V, you do not need a current limiting resistor R1. If the output exceeds 12.5V, however, please connect the current limiting resistor R1.

R1 Recommended resistor [Ω]	Ri : 780[Ω]
$R1 = \frac{V1 - (1.1 + Ri \times 0.005)}{0.005}$	

Table 6.6 Specifications of remote ON/OFF

Fig6.4 RC circuit example	-R3	
SW Lgic	Output on	SW short (3mA min)
	Output on	SW open (0.1mA max)

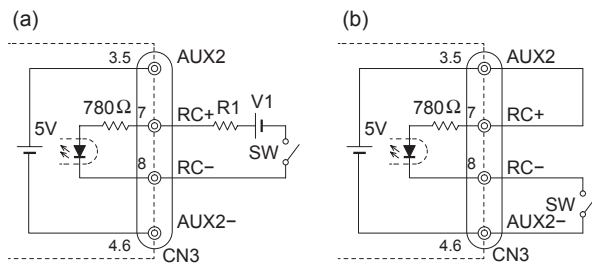

Fig 6.4 RC circuit example

■Alarm

- ①PR: abnormal input voltage
- ②LV: drop and shut-off of output voltage

Table 6.7 Explanation of alarms

	Alarm	Output of alarm
PR	When the input voltage is abnormal (low input voltage), the alarm signal is output from CN3.	Open collector method Good : Low (0-0.8V, 1mA max) Bad : High or open (50V max)
PG	When the rated output voltage decreases or stops, the alarm signal is output from CN3. Note : When the overcurrent protection activated, the PG alarm will be unstable.	Open collector method Good : Low (0-0.8V, 1mA max) Bad : High or open (50V max)

The alarm circuits (PR and PG) are isolated from others (the input, outputs, FG, AUX and other function terminals).

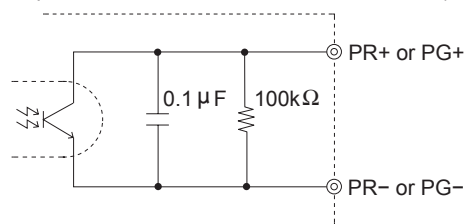

Fig 6.5 internal circuit of PR or PG

● -T5

- Acquired UL508. UL 62368-1 and EN 62368-1 are compliant.
 - CN1 and CN2 will be changed to push-in type terminal blocks.
- Please contact us for any other conditions.

● -P5

- Overcurrent protection will be changed to shut down mode from hic-cup mode.
- Please contact us for any other conditions.

6.2 Medical Isolation Grade

■ AEA series fit 2MOPP

■ Type BF

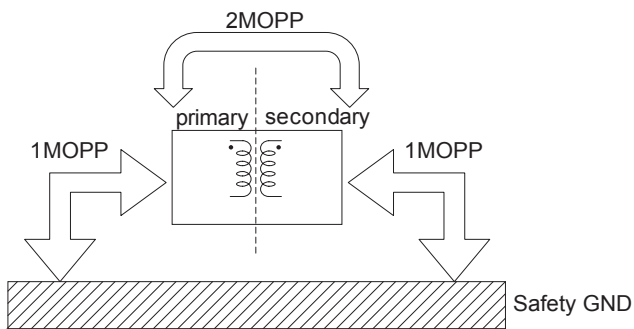

Fig.6.6 Medical Isolation Grade